



PageWriter[®] 2000X
TWO-WAY WIRELESS COMMUNICATIONS CENTER

ATTENTION

If you are currently using a PageWriter 2000 Smart Pager or a PageWriter 2000X Two-Way Wireless Communications Center, and you want to move your data from your old device to your new device, visit this web site for complete instructions:

<http://www.mot.com/smartupgrade>

CAUTION

DO NOT use the FLEX™ PC Partner Backup/Restore utility to move data from your old device to your new device.

If you currently use an application that requires a subscriber service and your PIN has changed, please contact your service provider and give them your new PIN.

For additional information or assistance with this process, call: 1-800-548-9954.



Quick Start
Guide Inside

User's Guide

PageWriter™ 2000X



6881033B75-A

Quick Start Guide

ONE (1) YEAR STANDARD LIMITED WARRANTY AND PROVISIONS (U.S.A. ONLY)

Installing the Battery

- Holding the pager face down, press down on the arrow in the center of the battery door and slide the door away from the center of your pager.
- Match positive (+) marking on the battery with the two-contact side of the pager's battery compartment and the negative (-) marking with the one-contact side of the battery compartment.
- Insert battery into the battery compartment at an angle toward the outer edge of the pager, ensuring the white lift tab is underneath the battery, and then press the battery down into place.
- Fold the lift tab down on top of the battery, and slide the battery door back into place.

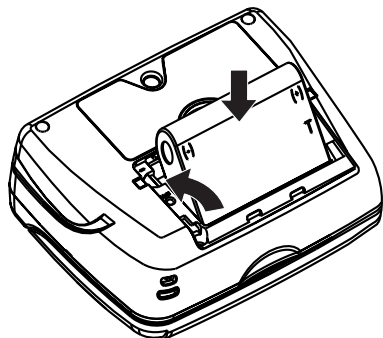

Installing the Charger

- Plug the transformer into any standard 120Vac outlet (as shown on right).
- Press the pager firmly into the charger until it *snaps into place* and the Red LED on the charger illuminates.

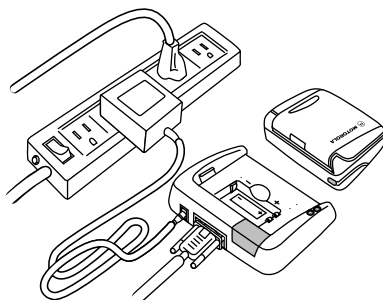

Charging the Battery

- Open the front flip on the pager.
The splash screen (as shown on right) will display within a few minutes. As the battery charges, the charging indicator (as shown bottom right) will move across the screen, until the screen is completely covered. This process usually takes about 10 minutes.
- Leave your pager in the charger until the Green LED on the charger turns on and the Red LED turns off. This may take another 40-60 minutes. During this time, you can begin to set up your pager starting on page 19 of the User Guide. After the battery has charged to a minimum level, the Home screen will display (page 6).

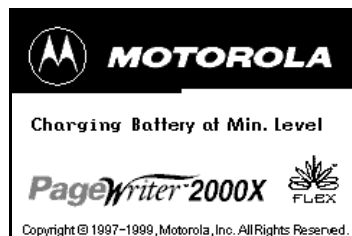
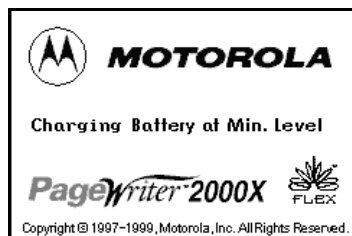

Motorola warrants the pager against defects in material and workmanship under normal use and service for the period of time specified below. This express warranty is extended by Motorola, 1500 Gateway Blvd., Boynton Beach, Florida 33426 to the original end user purchaser only and is not assignable or transferable to any other party.

This warranty sets forth the full extent of MOTOROLA's responsibilities regarding the pager. Repair, replacement, or refund of the purchase price, at MOTOROLA's option, is the exclusive remedy. THIS WARRANTY IS GIVEN IN LIEU OF ALL OTHER WARRANTIES, EXPRESS OR IMPLIED, INCLUDING WITHOUT LIMITATION, IMPLIED WARRANTIES OF MERCHANTABILITY AND FITNESS FOR A PARTICULAR PURPOSE. THIS WARRANTY IS LIMITED TO THE DURATION CHOSEN. IN NO EVENT SHALL MOTOROLA BE LIABLE FOR DAMAGES IN EXCESS OF THE PURCHASE PRICE OF THE MOTOROLA PAGER, FOR ANY LOSS OF USE, LOSS OF TIME, INCONVENIENCE, COMMERCIAL LOSS, LOST PROFITS OR SAVINGS OR OTHER INCIDENTAL, SPECIAL OR CONSEQUENTIAL DAMAGES ARISING OUT OF THE USE OR INABILITY TO USE SUCH PRODUCT, TO THE FULL EXTENT SUCH MAY BE DISCLAIMED BY LAW.

Motorola pagers are shipped from the factory with a standard limited warranty of one (1) year on parts and labor from date of purchase by the original end user purchaser, based on proof of purchase. In the event of defect, malfunction, or failure to conform to specifications during the warranty period, Motorola, at its option, will either repair, replace or refund the purchase price of the pager. Repair, at Motorola's option, may include the replacement of parts or boards with functionally equivalent reconditioned or new parts or boards. Replaced parts and boards are warranted for the balance of the original warranty period.

All parts and boards removed in the replacement process shall become the property of Motorola. This warranty does not cover defects, malfunctions, performance failures or damages to the unit resulting from use in other than its normal and customary manner, misuse, accident or neglect, the use of non-conforming parts, or improper alterations or repairs. This warranty does not cover wear and tear on covers or housings, nor the coverage or range over which the pager will receive signals.

For information on how to receive service on Motorola pagers or covered accessories, call 1-800-548-9954 or 1-800-793-7834 (TTY).

Pager warranty will be VOID if any of the following conditions occur:

- Pagers that are incomplete such as those in which boards or components are missing and/or incompatible.
- Pagers whose serial numbers do not match on the boards, or pagers in which the board serial numbers don't match the housing.
- Pagers that have been opened by, or had work performed by, anyone other than a Motorola authorized pager service center.
- Pagers received with non-conforming or non-Motorola housings or parts.

Flat rate repair fees apply to pagers and accessories are not covered under warranty.

STATE LAW RIGHTS

SOME STATES DO NOT ALLOW THE EXCLUSION OR LIMITATION OF INCIDENTAL OR CONSEQUENTIAL DAMAGES, OR LIMITATION ON HOW LONG AN IMPLIED WARRANTY LASTS, THEREFORE THE ABOVE LIMITATIONS OR EXCLUSIONS MAY NOT APPLY. This warranty gives you specific legal rights and you may also have other rights which vary from state to state.

MOTOROLA LICENSE AGREEMENT

IMPORTANT-READ CAREFULLY: This license agreement is a legal agreement between you and Motorola, which includes computer software and associated media and printed materials, and may include “online” or electronic documentation (“SOFTWARE”).

By installing, copying or using the SOFTWARE, you agree to be bound by the terms of this license agreement. If you do not agree with the terms of this license agreement, promptly return the unused SOFTWARE to the place from which you obtained it for a full refund.

The copyrights laws and international copyright treaties, as well as other intellectual property laws and treaties, protect this SOFTWARE.



1. You may install and use one copy of this SOFTWARE on a single computer. The SOFTWARE may not be used by more than two (2) processors at any one time on the single computer running the SOFTWARE.
2. You may not reverse engineer, decompile or disassemble the SOFTWARE.
3. The SOFTWARE is licensed as a single product. Its components may not be separated for use on more than one computer.
4. You may not rent or lease the SOFTWARE.
5. You may transfer your rights under this license, provided you retain no copies, you transfer all of the SOFTWARE (including all component parts, the media, and printed materials and this license agreement) and the recipient agrees to the terms of this license.
6. If you fail to comply with the terms of this license, Motorola may terminate this license agreement, without prejudice to any other rights that Motorola may have. In such event, you must destroy all copies of the SOFTWARE and all of its component parts.
7. Motorola owns all title and copyrights in and to the SOFTWARE and any copies of the SOFTWARE. Copyright laws and international treaties protect the SOFTWARE. However, you may either (1) make one copy of the SOFTWARE for backup or archival purposes or (2) install the SOFTWARE on a single computer provided that you keep the original solely for backup or archival purposes. You may not copy the printed materials accompanying the SOFTWARE.
8. The SOFTWARE and documentation are provided with RESTRICTED RIGHTS. Use, duplication, or disclosure by the Government is subject to restrictions set forth in subparagraph (c)(1)(ii) of the Rights in Technical Data and Computer software clause at DFARS 252.227-7013 or subparagraphs (c)(1) and (c)(2) of the Commercial Computer Software-Restricted Rights at 48 CFR 52.227-19, as applicable. The manufacturer is Motorola, Inc., 3301 Quantum Blvd., Boynton Beach, FL 33426-8622.
9. You agree that you will not export or re-export the SOFTWARE to any country, person, entity or end users subject to U.S. export restrictions. You warrant that your export privileges have not been suspended, revoked or denied by the U.S. Bureau of Export Administration or any other federal agency.
10. EXPORT LAW ASSURANCES: You hereby agree to comply fully with the export regulations of the United States of America. You agree that you will not export the Software without an export license issued by the U.S. Department of Commerce. You hereby agree to comply with all regulatory sanctions or restrictions involving a party or an entity identified as Denied Parties or Specially Designated Nationals by the U.S. Department of Commerce and/or the U.S. Department of Treasury.



Motorola, Inc. makes no representations or warranties with respect to the contents or use of this manual and specifically disclaims any warranties, express or implied, of merchantability or fitness for any specific purpose. Further, Motorola, Inc. reserves the right to revise this publication and to make any modifications to its content, at any time, without obligation to notify any party, person, or entity of such revisions or changes.

© 1999 by Motorola, Inc. All Rights Reserved.
Personal Communications Sector
1500 Gateway Blvd.
Boynton Beach, FL 33426-8292
Printed in the United States of America 4/99

Ⓜ, Motorola, PageWriter, PC Partner, and FLEX are trademarks or registered trademarks of Motorola, Inc.
Reg. U.S. Pat. & TM. Off.

Contents

Welcome	1
Using This Manual	3
Conventions	3
Finding Help	4
Getting Started	5
What's in the Box?	5
Paging Service Instructions	5
How Your PageWriter 2000X Pager Works	6
The Flip	6
The Home Screen	6
The Keyboard	9
The Battery and Charger	12
The Infrared Port	17
The Holster	18
System Setup	19
Turning On and Off Your PageWriter 2000X Pager	19
Configuring Your PageWriter 2000X Pager	23
Setting the Date and Time	24
Assigning Alert Modes	25
Assigning Alert Types	26
 Addresses	27
Entering Addresses	27
Editing Addresses	29
Deleting Addresses	30
 Write	31
Writing Messages	31
Importing Messages	32
Adding Quick Text	33
Attaching Message Replies	33
Saving Your Message to the Drafts Inbox	33
Scheduling a Delayed Send	34
Filing a Message Draft	34
Entering a One-Time Address	35
 Read	36
Reading Incoming Messages	36
Setting a Reminder Message Alarm	37
Sending Responses	37
Forwarding Messages	38
Filing Messages	39
Deleting Messages	39

	Managing the Message Area	39
	Customize	47
	Viewing System Status	47
	Enabling and Disabling Alerts and Alarms	48
	Setting Up Internet Fax Service	48
	Customizing the User Interface	49
	Customizing Message Features	50
	Quiet Time	51
	Maintaining Inboxes and Applications	52
	Setting the Alarm Clock	53
	FLEX PC Partner	54
	Introducing FLEX PC Partner	54
	Installing FLEX PC Partner on Your PC	55
	Linking Your PageWriter 2000X Pager to Your PC	55
	Configuring FLEX PC Partner	56
	Using the PC Partner Shell	57
	Managing Your Address Book	58
	Managing Your Messages	69
	Installing and Removing Applications	70
	Backing-up and Restoring Information	71
	Checking Memory Usage on Your PageWriter 2000X	73
	Uninstalling FLEX PC Partner	73
	Memory Management System	74
	Proper Care and Cleaning	75
	General Safety Instructions	76
	Pager Transmitter Safety	76
	Battery Safety	76
	Battery Charger Safety	76
	Agency Approvals	77
	Patent Information	77
	PageWriter 2000X Pager Specifications	78
	Commonly Asked Questions	79
	PageWriter 2000X Pager	79
	Messaging	80
	Battery and Charger	83
	FLEX PC Partner	84
	Index	87

Welcome

Congratulations! Your new Motorola PageWriter™ 2000X Two-Way Wireless Communications Center is about to change the way you communicate. With features such as wireless, smart paging and user-upgradeable system software and applications, your PageWriter 2000X pager places you in control of your personal communications. You can now send messages, control incoming messages, and customize the device with applications that you select.

This pocket message center features a QWERTY keyboard and high-resolution graphics display. It enables you to communicate wirelessly with Internet email addresses, fax machines, and other pagers, yet is small enough to comfortably wear on your belt or fit in your pocket.

The PageWriter 2000X Two-Way Wireless Communications Center uses FLEX™ Operating System (FLEX OS), Motorola's new open-standard operating system for messaging products, and FLEX Protocol for Two-Way Paging, Motorola's high-speed two-way paging technology.

The built-in suite of software applications includes:

Read — Read incoming messages, including personal, service bureau, and reminder messages.

Write — Create and send messages to another pager, an email address, or a fax machine without searching for a phone. Receive and respond to messages from the same device.

Addresses — Store your personal directory of names, phone numbers, email addresses, and related information, and retrieve easily.

Customize — Use *set-and-forget* functions to customize your preferences such as message text size, unread message alerts (on/off), and date/time formats.

Set Time — Quickly adjust the time or date to reflect your movement between time zones or seasonal changes such as Daylight Savings Time.

Partner — Keep all your records in sync using Motorola's FLEX™ PC Partner connectivity software. Update the Address Book on your computer by transferring your Address Book files from your PageWriter 2000X Two-Way Wireless Communications Center to your personal computer.

Additionally, changes made to your Address Book on your computer can be transferred back to your pager.

Alarm Clock — Set audible or vibrating personal alarms at up to three different times and frequencies.

Radio Mode — Set your transmission mode to accommodate your environment. Your PageWriter 2000X Two-Way Wireless Communications Center accommodates the special requirements of hospital or medical facilities and airline travel.

Finally, everything you need in a smart, customizable paging device! Life just got easier. Consolidate your communications onto one device — your *all-in-one* PageWriter 2000X Two-Way Wireless Communications Center from Motorola.

*The efficiency and affordability of a pager...
The convenience of full text response.*

Using This Manual

Conventions

This manual uses several conventions to differentiate between command and key access on your PageWriter 2000X Two-Way Wireless Communications Center and your personal computer (PC). Specific conventions are also used to highlight additional helpful information in the form of tips, notes, and cautions. Before you begin, please refer to the following conventions:

On the PageWriter 2000X Pager



Icons represent each application on the PageWriter 2000X menu wheel.



White buttons identify command buttons that appear on the screen.



Gray keys identify PageWriter 2000X keyboard keys.



Two keys means to press the first key, release, then press the second key. Do not hold down **ALT** or **SHIFT** while pressing the next key.

Bold Text

Bold Text indicates text to select on the PageWriter 2000X screen or to type into a field.



Means to press the NavDisc™ (left, right, up, down) to move *within a field* (text field, list field, button field).



Means to press **TAB** to move *between fields* (list field to button field).

“Select”

Means to highlight a list item, application, icon, or command button, then press



On the PC



Address Book

Icons represent each application in the PC Partner Shell.



Icons represent menu options that can be selected from the menu bar.

E

Shadowed keys indicate PC keyboard keys.

Bold Text

Bold text indicates menu options or command buttons to select or text to type into a field.

Additional Information

TIP

Identifies actions you can perform to increase your ease of use and efficiency.



Provides further information about the procedural step or feature.

CAUTION

Identifies actions that can cause loss of data or damage to the product.

Finding Help

We welcome your suggestions on how we can improve our products and want to hear about any problems you may be experiencing. To contact us about suggestions or concerns, or for more information about the PageWriter 2000X Two-Way Wireless Communications Center, its accessories, or other Motorola products, call:

1-800-548-9954

Or, visit our website:

<http://www.motorola.com/SmartPagers>

Getting Started

What's in the Box?

Your new PageWriter 2000X Two-Way Wireless Communications Center comes with:

- 1 PageWriter 2000X Pager
- 1 NiMH Battery
- 1 Holster
- 1 Charger Base/Docking Station
- 1 120 Vac Transformer
- 1 RS232 Null Modem Serial Cable
- 1 FLEX PC Partner Connectivity Software Disk
- Product Literature (User's Manual, Quick Reference Card, Registration Card)

Paging Service Instructions

To begin paging service, contact your paging service provider for activation instructions. Your PIN number and the phone number of the paging service can be found in the literature provided by the paging service. Use this manual for device-specific operating instructions.

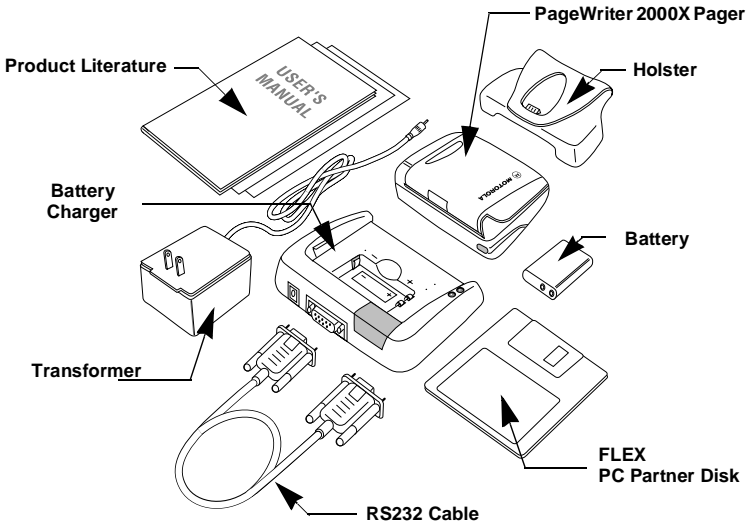

How Your PageWriter 2000X Pager Works

The PageWriter 2000X Two-Way Wireless Communications Center's lightweight, wearable design allows you to open the flip and read your messages while the pager is still in the belt holster. Audio and vibrate alerts notify you of incoming and waiting messages. The keyboard provides text entry capabilities that allow you to send full text messages. All this is combined with the ability to add applications, upgrade current applications, and, with the infrared interface in the Motorola Deluxe model, upload and download information to and from your computer.

TIP The PageWriter 2000X Two-Way Wireless Communications Center displays a blank screen to conserve energy during periods of inactivity. Press any key to awaken the pager.

The Flip

The front flip on the PageWriter 2000X Two-Way Wireless Communications Center houses and protects its LCD screen and antennae. Opening the flip awakens the pager, while closing the flip puts the screen into sleep mode. When in sleep mode, your PageWriter 2000X Two-Way Wireless Communications Center continues to work for you. It receives and stores incoming messages for access at your convenience. You can set audible, vibrating, or silent alerts to notify you when messages are received.

The Home Screen

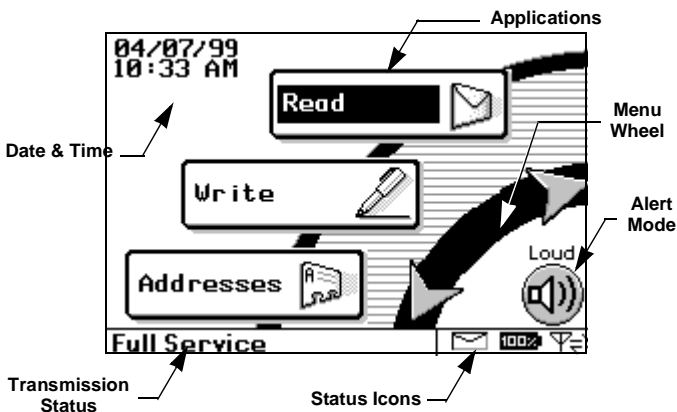

The Home screen's menu wheel provides quick access to both pre-loaded applications and those you add yourself.

Press the NavDisc™  up or down to highlight an application. Continue pressing the NavDisc in the same direction and the wheel spins in that direction to display the next three applications.

TIP To select an application from the menu wheel without scrolling through the menu, press the first letter of the application's name. The menu wheel spins to the first application beginning with the selected letter. These are called *shortcuts*. Shortcuts also work on menu lists such as your Message Area container list.

If more than one application or more than one list entry starts with the same letter, the shortcut takes you to the first occurrence of the letter. Press the letter again and the shortcut takes you to the next occurrence of the letter.

The Home screen also provides at a glance the basic status of your PageWriter 2000X Two-Way Wireless Communications Center, including:

Date and Time — Always displays the date and time for your convenience; select the Set Time application from the menu wheel to change the date or time; select the Customize application from the menu wheel to change the format for the date or time.

Alert Mode — Displays the current alert mode. Alert modes override or enhance the assigned alert types. For more information, see “Assigning Alert Modes” on page 25. To set specific alerts, see “Assigning Alert Types” on page 26.

 **Loud** — Enables all audible alerts to the loud volume.

 **Soft** — Enables all audible alerts to the soft volume.

 **Vibrate** — Enables all alerts to vibrate without changing the individual alert settings.

 **Silent** — Disables the alerts without changing the settings. Select Loud or Soft to enable the alert settings at the preferred volume.

Battery Gauge — Displays a four-level graphic indicator of the remaining power in the rechargeable battery.

 **Full** — Approximately at full charge.

 **2/3** — Approximately at two-thirds capacity.

 **1/3** — Approximately at one-third capacity.

 **Low Cell** — Almost drained of charge.



Status Line — On the menu wheel, displays the in-range/out-of-range transmission status (Basic Service, Full Service, or Storing Messages); for more information, see “To set the transmission mode:” on page 23.



On application screens, explains the function of the highlighted button or special status icon.

Special Status Icons — Displays graphic indicators for the following conditions:

 **New Message Waiting** — Unread messages are in one or more inboxes.

 **Send/Receive** — Full Service coverage. Two-way messaging; turns on the transmitter and receiver.

  **Receive Only** — Basic Service coverage. One-way messaging; turns on only the receiver. Accompanied by a symbol of a heart with a cross in it, sometimes referred to as Hospital mode. The unit will never transmit while in this safe mode for environments with sensitive equipment (such as CAT Scan and MRI equipment found in hospitals).

  **Off** — Storing Messages coverage. You have manually turned off the transmitter and receiver. Accompanied by an airplane to show this is the safe mode for electronic devices used in airplanes. See “Configuring Your PageWriter 2000X Pager” on page 23 for information on turning the transmitter and receiver back on.

 **Out of Range** — Your pager is too far from a transmitter to receive messages.

 **Memory Low** — Available memory is running low; older messages will be automatically deleted to free memory for new messages. For more information, see “Memory Management System” on page 74.

Alt **Alt** — Alt mode is turned on; the next key pressed will indicate an Alt-mode function. For more information, see “Alt Functions” on page 11.

Shift **Shift** — Shift mode is turned on; the next letter will be capitalized, or the next control key pressed will indicate a Shift-mode function. For more information, see “Shift-mode Functions” on page 12.

CAPS Caps Lock — Caps Lock setting is turned on; all letters will be capitalized.

The Keyboard

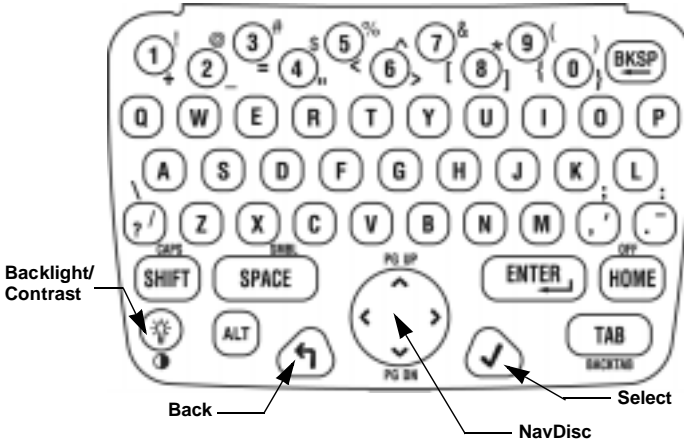

The PageWriter 2000X Two-Way Wireless Communications Center comes with a QWERTY keyboard. Special control keys and key combinations provide the following functions.

Standard Control Keys

 **NavDisc** — Moves the cursor *within* a field (i.e., text field, list field, button field). Press the outside edge of the NavDisc to move the cursor in that direction. In a text field, moves the cursor between characters. In a button field, the NavDisc scrolls the cursor between command options.

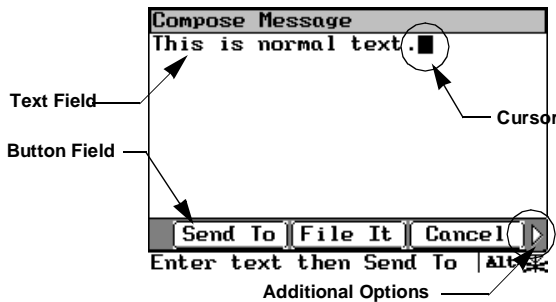

- TAB** **Tab** — Moves the cursor *between* fields (e.g., text field to button field). From the text field, press Tab to access the button field. Continue pressing tab to cycle back to your initial starting point, or press **ALT TAB** to tab backward.
- ↶** **Back** — Cancels input for the current screen and goes back to previous screen. Continue pressing **↶** to return to the Home Screen.
- ✓** **Select** — Selects a highlighted item from a list or activates the button highlighted by the cursor. Highlight the list item or button, then press **✓** to select.

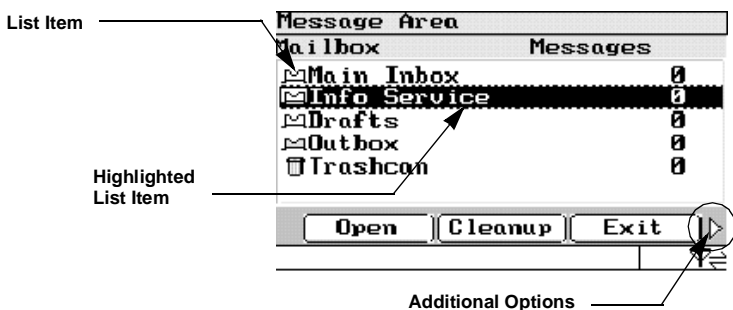

- HOME** **Home** — Returns to the menu wheel (Home) screen.
- BKSP** **Backspace** — When the cursor is positioned in text, it deletes the character preceding the cursor.
- SPACE** **Space** — Inserts a space in text.
- ENTER** **Enter** — Inserts a paragraph return in text and acts as a select key on non-text fields.
- ALT** **Alt** — Activates the Alt-mode control keys, which are color-coded blue on the keyboard. Press **ALT**, then release. The status icon **Alt** appears on the screen. The next key pressed will indicate the Alt-mode function. Alt-mode characters are color-coded blue on the keyboard near the corresponding control key.
Do not hold down **ALT** while pressing the next key. Alt mode turns off when **ALT** is pressed again or when a key other than an Alt-mode key is pressed.

SHIFT **Shift** — Activates the Shift-mode control keys. Press **SHIFT** then release. The status icon **Shft** appears on the screen. The next letter pressed will be capitalized, or the next control key pressed will indicate a Shift-mode function. Shift-mode characters are color-coded white on the keyboard near the corresponding control key. Three other keys (**?**, **.**, **-**) provide Shift-mode access to three more symbols (*/ ç -*). Do not hold down **SHIFT** while pressing the next key.

Shift mode turns off when **SHIFT** is pressed again or when a key other than a Shift-mode key is pressed.

Backlight — Illuminates the screen and the keyboard. The backlight remains on until the display times out, the flip is closed, or you press **?** again.

Alt Functions

Thirteen symbols (colored *blue* on the keyboard) are available using the Alt mode. The number keys plus three other keys (**?**, **.**, **-**) are used by pressing **ALT**, then the corresponding key.

1	+	2	_	3	=	4	“	5	<	6	>	7	[
8]	9	{	0	}	?	\	,	;	.	:		

Alt-mode Functions

ALT **?** **Contrast** — Adjusts the contrast; the difference between the lightest and darkest areas on the display. Press **ALT**, then hold down **?**. The contrast value will progress to extreme light or dark, then reverse. Release **?** when you see the desired contrast setting.



ALT **HOME** **Off** — Turns off the pager. When the pager is off, press any key to turn it back on.

ALT **SHIFT** **Caps Lock** — Activates Caps Lock. Each letter pressed is capitalized until **ALT** **SHIFT** is pressed again.



ALT SPACE Symbols — Activates the Symbols key. Fifteen (15) additional symbols can be used. Press **ALT SPACE** to view the Symbols screen, then press the key that corresponds to the symbol you want to add to your message. The original screen reappears with the symbol added to your text. Most of the symbols are also available on the keyboard using the Alt mode.

1	+	2	=	3	~	4	<	5	>	6	^	7	&	8	“
9	;	0	\	a	[b]	c	{	d	}	e			

ALT TAB BackTab — Reverses the direction of **TAB** for one key press.

ALT  **Page Up/Page Down** — Activates Page Up and Page Down and disables Page Right and Left for one key press. In the Message Area, press **ALT**  to move to the top or bottom of the list.

Shift-mode Functions

Thirteen symbols (colored *white* on the keyboard) are available using the Shift mode. The number keys plus three other keys (, , ) are used by pressing **SHIFT**, then the corresponding key.

1	!	2	@	3	#	4	\$	5	%	6	^	7	&
8	*	9	(0)	?	/	,	¢	.	-		

The Battery and Charger

Motorola batteries and chargers are made from the highest-quality materials available. The battery and charger included with the PageWriter 2000X Two-Way Wireless Communications Center come with a one year warranty and should provide good performance well beyond the initial warranty period. However, rechargeable batteries do not last forever. At some point, batteries wear out and must be replaced. If your battery's performance has degraded (e.g., the battery's charge lasts only half as long as when it was new), you should consider replacing your battery with a new Motorola factory-assured battery. Batteries, as well as any other Motorola PageWriter 2000X Two-Way Wireless Communications Center accessory, can be purchased through your dealer, or by calling Motorola direct at 1-800-548-9954.

TIP Before leaving on a trip, make sure the battery and any extra batteries are fully charged. All rechargeable batteries experience *self-discharge*, meaning that a small amount of energy discharges everyday as a battery sits on the shelf. Recharging the batteries to full charge should take an hour or less per battery.

Recharging can be accomplished by placing your PageWriter 2000X Two-Way Wireless Communications Center in the charger or by removing the battery and placing only the battery in the charger. For optimum performance, use the recommended Motorola charger.

To recharge the battery without removing it from the pager:

1. Insert the transformer's round connector into the connector on the back of the charger.

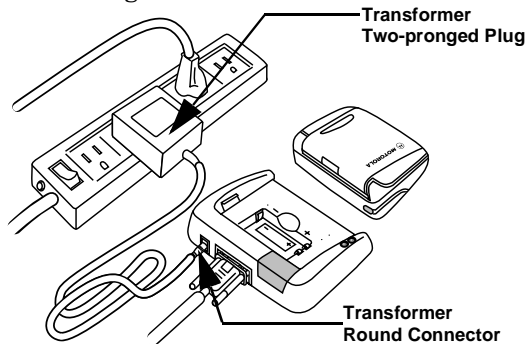

2. Insert the transformer's two-pronged plug into any standard 120 Vac power supply outlet.
3. Hold the pager face up over the charger.
4. Position the pager with the Motorola logo on the same side as the charger's red and green LED indicators.

The battery can be charged separately or while it is in the

pager. The charger is intentionally designed so that you cannot place both the extra battery and the pager in the charger at the same time.

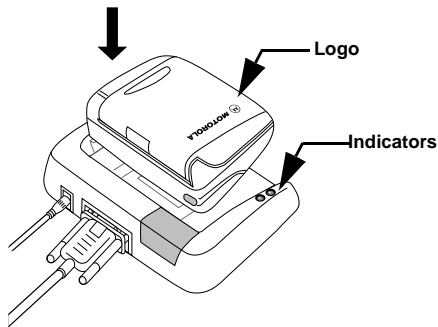

5. Press the pager down into the charger until an audible click is heard. The red LED indicator light means the battery is charging.
 - ↪ A flashing red LED indicator means the battery is not making a good contact. Ensure the pager is properly seated in the charger.
6. When the green LED indicator lights, the battery is fully charged. Slide the pager forward to release it from the charger.

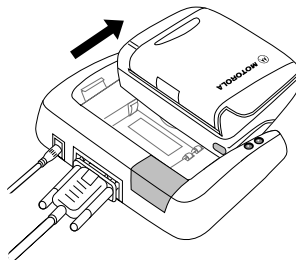

7. Remove the round transformer connector from the back of the charger, then remove the plug from the power supply.

To remove the battery for charging:

1. Hold the pager face down.
2. Press down on the arrow in the center of the battery door and slide the battery door away from the center of the pager.

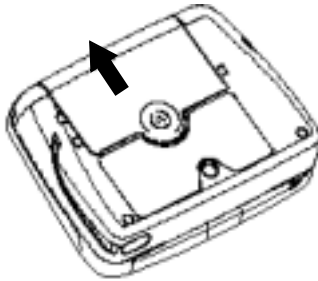

3. Lift the battery door away from the pager.

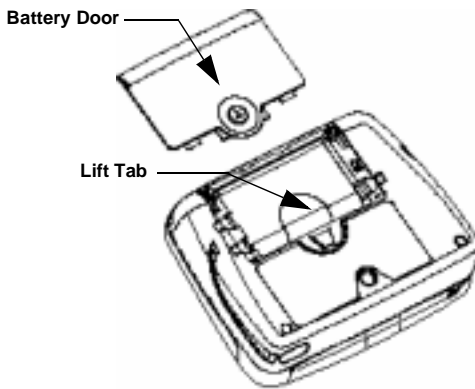

4. Using the white lift tab, lift the battery from the battery compartment.

To recharge the battery outside of the pager:

1. Insert the transformer's round connector into the back of the charger.

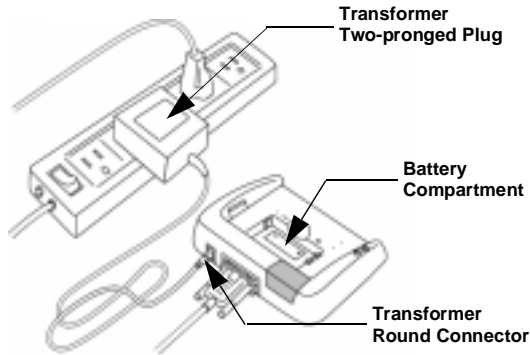

2. Insert the transformer's two-pronged plug into any standard 120 Vac power supply outlet.
 3. Place the 3.6 V NiMH battery in the charger's battery compartment by aligning the positive (+) and negative (-) markings on the battery with those on the charger.
 4. Press the battery firmly into place. The lit red LED indicator light means that the battery is charging.
- ↪ A flashing red LED indicator means the battery is not making a good contact. Ensure the pager is properly seated in the charger.
5. When the green LED indicator becomes lit, the battery is fully charged. Remove the battery from the front of the charger.

TIP Leaving the battery in the charger after the LED turns green keeps the battery fully charged until removed. Keep your spare battery fully charged by leaving it in your plugged-in charger.

To replace the battery:

1. Match the positive (+) marking on the fresh battery with the two (2) contact side of the pager's battery compartment and the negative (-) marking with the one (1) contact side of the battery compartment.
2. Insert the battery into the battery compartment at an angle toward the outer edge of the pager, then press the battery down into place.

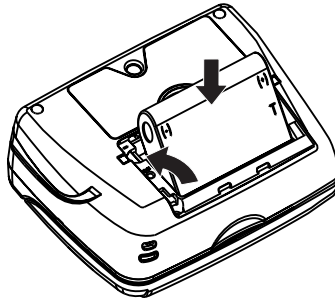

- ↙ Ensure the lift tab is underneath, not on top of, the battery. The tab is designed to help lift the battery out of the compartment during battery removal.
3. Fold the protruding lift tab down on top of the battery, then slide the battery door back into place. An audible click can be heard when the door is securely closed.

The Infrared Port

The PageWriter 2000X Two-Way Wireless Communications Center includes an infrared (IR) port in the charger housing. This device is used as a *docking station* for your pager when transferring data to and from your computer. The IR port on the docking station with the IR port on your PageWriter 2000X Two-Way Wireless Communications Center, enabling data transmission. The docking station is connected to your computer with the Motorola-provided RS232 null modem cable.

When a data transfer is in process between the pager and a PC, the green and red LED indicator lights on the PageWriter 2000X pager will flash intermittently.

To connect the docking station to your computer:

1. Connect one end of the RS232 cable to your computer's nine-pin serial port.
2. Connect the other end of the RS232 cable to the nine-pin connector in the back of the docking station.

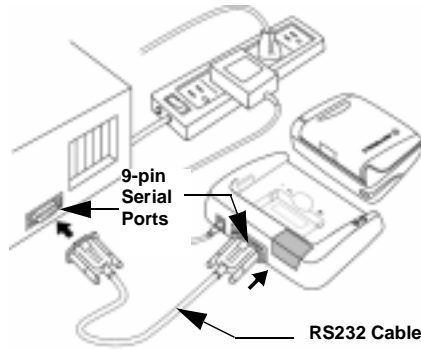

3. Insert the transformer's round connector into the back of the charger.
4. Insert the transformer's two-pronged plug into the power supply.
5. Snap your PageWriter 2000X Two-Way Wireless Communications Center into the charger. You are now ready to access the FLEX PC Partner application from your PageWriter 2000X Two-Way Wireless Communications Center's Home menu wheel. See "FLEX PC Partner" on page 54 for more information on using the FLEX PC Partner application.

The Holster

The durable, clip-on holster allows you to comfortably wear your PageWriter 2000X Two-Way Wireless Communications Center on your belt or pocket. Additional accessories are also available. For more information, call 1-800-548-9954.

System Setup

Your PageWriter 2000X Two-Way Wireless Communications Center comes pre-configured and ready for use. Features are available that allow you to re-configure your pager to more closely reflect your lifestyle, set the date and time, and select the alert modes and types. For information on customizing other features, see “Customize” on page 47.

Turning On and Off Your PageWriter 2000X Pager

The rechargeable battery in your PageWriter 2000X Two-Way Wireless Communications Center allows you to leave your pager turned on 24 hours a day and, depending upon usage, can sustain operation for approximately a week before requiring a recharge. However, your PageWriter 2000X Two-Way Wireless Communications Center works much like your computer. Periodically turning off your pager assists in clearing the random-access memory (RAM) and can help optimize your pager’s performance. Turning off your pager at night will also lengthen the time of your battery’s charge.

TIP Incoming messages are stored by the paging service until your pager is turned back on and ready to receive messages. Turn your pager off at night when you do not want to receive messages, and place the pager in the plugged-in charger so it will be fully charged and ready for use in the morning. If you prefer to leave your pager on, use the Quiet Time feature to specify the time period that message alerts will not be played.

To turn on your pager:

Press any key.

To turn off your pager:

1. Press  .

-or-

2. Select  from the menu wheel.

To reset your pager:

Turn off your pager as indicated in the previous procedure, then press any key to turn the pager back on.

-or-

1. Hold the pager face down.

2. Press down on the arrow in the center of the battery door and slide the battery door away from the center of the pager.

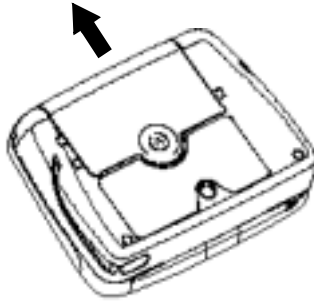

3. Lift the battery door away from the pager.

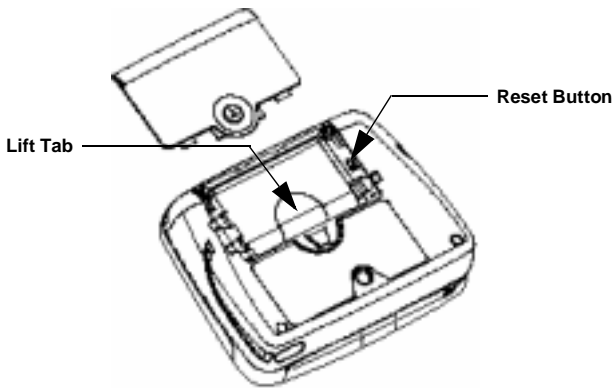

4. Using a pen or other small pointed object, press the reset button.
5. Fold the protruding lift tab down on top of the battery, then slide the battery door back into place. An audible click can be heard when the door is securely closed.

Migrating from Your PageWriter 2000 Smart Pager to the PageWriter 2000X Two-Way Wireless Communications Center

Attention! Current users of the PageWriter™ 2000 Smart Pager. PLEASE READ THIS IMPORTANT INFORMATION about migrating from your PageWriter 2000 Smart Pager to the PageWriter 2000X Two-Way Wireless Communications Center.

Congratulations! You are very close to enjoying all of the power of your new PageWriter 2000X Two-Way Wireless Communications Center. Please follow these instructions to successfully migrate data and services from your PageWriter 2000 Smart Pager Version 1.0.50, 1.0.70.3 or 2.0.1.14 to your new unit. View your Smart Pager Version number as follows:

Select  from the menu wheel, and then select **About PageWriter...**





If you have any of the version numbers listed above, these instructions will help you migrate all your data, messages, preferences, and add-on applications (from Motorola Inc. or other sources), to your new unit.

Caution! DO NOT use the PC Partner Restore utility to migrate your data. Use only the **System Maintenance Utility**, the **PC Partner Backup** utility, and these instructions to perform this operation.

If any application to be migrated has a subscriber service associated with it, **and your PIN has changed**, you will need to contact the respective service provider and inform them that you have a new PageWriter 2000X Two-Way Wireless Communications Center unit. They will probably ask you for your new PIN number or code(s) to continue the service to your new unit.

PLEASE! Carefully read ALL the instructions first.

1. On your PC, install the new FLEX PC Partner application (v.2.0.0.16) that came with your new unit.
2. Download the **System Maintenance Utility** for the PageWriter 2000X Two-Way Wireless Communications Center from the Motorola website:
<http://www.mot.com/pw-solutions>
Choose FLEX OS upgrade and follow the instructions for downloading.

3. Insert your "old" PageWriter 2000 Smart Pager, version 1.0.50, or 1.0.70.3, or 2.0.1.14 in the docking station.
4. Select  from the menu wheel, and then select . Wait until the Connection Status screen appears on your pager's display.
5. On your PC launch your new FLEX PC Partner application as follows: Click the **Start** button, select **Programs**, and then select **FLEX PC Partner**.
6. Double-click  **Backup Utility** to make a backup copy of your "old" PageWriter 2000 Smart Pager. Make a note of the name of the backup file. After the backup process is completed, remove your "old" PageWriter 2000 Smart Pager from the docking station.
7. Place your "new" PageWriter 2000X Two-Way Wireless Communications Center in the docking station.
8. Select  from the menu wheel, and then select . Wait until the Connection Status screen appears on your pager's display.
9. On your PC launch the **System Maintenance Utility** for the PageWriter 2000X Two-Way Wireless Communications Center. When prompted, choose the "**My pager is not functioning correctly**" option; this causes the **System Maintenance Utility** to restore data from a backup file.
10. Then, choose "**Restore my data using the backup file**". Click the **Browse** button, then move to the location of the backup file created in Step 5, and select that file.
11. Follow the instructions for connecting to your pager to complete the migration.

Now you are ready to enjoy your new PageWriter 2000X Two-Way Wireless Communications Center!

For additional information or assistance with this process, call: 1-800-548-9954



Configuring Your PageWriter 2000X Pager



Before attempting to send or receive messages, ensure your pager is set to the proper transmission mode. You can also adjust the message text size or turn on or off the audible keyboard clicks when preparing your pager for use.

To set the transmission mode:



1. Select  from the menu wheel.
2. Select the transmission mode:

 **Send/Receive** — Full service coverage. Turns on the receiver and transmitter for two-way message transmission. Messages can be sent and received from your pager.

  **Receive Only** — Basic Service coverage. Turns on only the receiver for one-way message transmission. Messages can be received but not sent from your pager.

  **Off** — Storing Messages. Turns off the transmitter and receiver. Messages cannot be sent or received.

TIP  Sometimes referred to as Hospital mode. The unit will never transmit while in this safe mode for environments with sensitive equipment such as CAT Scan and MRI equipment found in hospitals.

  Off is recommended for airline travel. Radio transmissions can interfere with flight navigation and communications. Follow FAA regulations. Turn off the transmitter while on airplanes.





3. Select  to return to the main screen.

 When the pager is in Off mode, messages are retained by the paging service until you change modes (Send/Receive or Receive Only).



TIP Off mode does not turn off your pager. It turns off the radio frequency (RF) transmission. You can still use the applications on your pager to update your Address Book, schedule reminders to yourself, or compose messages to be sent at a later time.

TIP When moving to another zone, reset your pager back to Full Service Send/Receive mode until you receive your first page, then you can put the pager back into Receive Only mode. This allows you to tell the service provider where to find your pager. Zones are defined by the paging service provider, but in general, a major metropolitan area counts as a zone (e.g., the greater Chicago area is one zone).

To change the message text size:

1. Select **Customize**  from the menu wheel.
2. Press  up or down to highlight **Message Text**, then press  or **ENTER** to toggle between:
[Now NORMAL]  Displays message text in the standard font size.
[Now LARGE]  Displays message text in a larger font size.
3. Press **TAB** to access the button field, then select **Done** to accept the changes and return to the menu wheel.

To turn on/off the audible keyboard click:





1. Select **Customize**  from the menu wheel.
2. Press  up or down to highlight **Key Clicks**, then press  to toggle between [Now ON] and [Now OFF].
3. Press **TAB** to access the button field, then select **Done** to accept the changes and return to the menu wheel.

Setting the Date and Time



Although your new PageWriter 2000X Two-Way Wireless Communications Center comes pre-configured, you might need to set the correct date and time when you first receive your pager. Through the Set Time application, you can also reset the date and time to reflect your movement between time zones and for seasonal changes, such as Daylight Savings Time.

To set the date/time:



1. Select **Set Time**  from the menu wheel.

- From the Time field, press  up or down in each field to change the hour, minute, or AM/PM. Press  right or left to move between Time fields.
- Press **TAB** to access the Date field, then press  up or down to change the numbers for the date. Press  right or left to move between Date fields.
- Press **TAB** to access the button field, then select **OK** to accept the changes and return to the menu wheel.

To select the date format:

- Select **Customize**  from the menu wheel.
- Press  up or down to highlight **Date Format**, then press  to cycle between:
 - [Now DD/MM/YY]** ↓ Displays day/month/year format.
 - [Now YY/MM/DD]** ↓ Displays year/month/day format.
 - [Now MM/DD/YY]** ↓ Displays month/day/year format.
- Press **TAB** to access the button field, then select **Done** to accept the changes and return to the menu wheel.



To select the time format:

- Select **Customize**  from the menu wheel.
- Press  up or down to highlight **Time Format**, then press  to toggle between **[Now AM/PM]** and **[Now 24 hr]**.
- Press **TAB** to access the button field, then select **Done** to accept the changes and return to the menu wheel.

Assigning Alert Modes

Four alert modes are available from the Home screen that quickly and easily override the alerts without changing the settings. They include Loud, Soft, Vibrate, and Silent. The alert modes allow you to increase the volume of the alert when you are in a noisy environment, decrease the volume for normal environments, substitute vibration when no sound is desired, and turn off the alerts for environments where any alert is inappropriate.





To select an alert mode:

1. From the Home screen, press  to the right or **TAB** to highlight the alert mode icon.
2. Press  to cycle to the desired alert mode.
3. Press  or **TAB** to exit the alert mode icon and accept the change.

Assigning Alert Types

Different alert types can be assigned to the inboxes that receive your messages. This allows you to identify by sound the type of message you are receiving. An alert type can be set for each of the alert modes. If an audible alert mode (Loud or Soft) is selected from the Home screen, the alert you assigned on the Set Alert Screen will notify you of incoming messages.

To select an alert type:

1. Select **Read**  from the menu wheel.
2. Press  up or down to highlight the inbox for which you are assigning an alert type, then select **Customize**.
3. Select **Next**  to bypass the Edit Inbox screen.
4. Press  left or right to scroll through the alert options. Press **TAB** to move between alert mode fields.

TIP Press **ENTER** to sample the alert.

5. Select **Done** to accept the changes and return to the Message Area screen.



Addresses

The PageWriter 2000X Two-Way Wireless Communications Center contains an address book for storing the address information of each person or group you might want to contact. You can include the type of pager and its PIN, an email address, a fax number, home and work phone numbers, and even miscellaneous notes for each address entry. When viewing address entries, the status bar notifies you if there is additional information not displayed on the screen.

TIP To view the additional data, press the NavDisc  down to scroll through the rest of the information.

When you are ready to send a message, each person or group will have an address entry for each type of address you have identified that the PageWriter 2000X Two-Way Wireless Communications Center can send messages to.

- ↪ The amount of entries in the Address Book is only limited by the amount of free memory available (see “Viewing System Status” on page 47 and “Checking Memory Usage on Your PageWriter 2000X” on page 73).
- ↪ Group names are indicated in the list of Address Book Entries with the label GROUP.
- ↪ Up to 25 members can be added to each group.









Entering Addresses

The Address Book contains addresses for individuals as well as for groups of individuals. Group addresses allow you to compose and send one message which is transmitted to each member of the group.

TIP You can force address names to appear in a position in the Address Book that you find convenient. For example, prefacing group names with a space forces all the groups to appear at the top of the list. Using an underscore instead forces the names to the bottom of the list.





To add an individual:

1. Select **Addresses**  from the menu wheel.
2. Select **New Individual Entry**.

3. In the Name field, type the name for the entry as it should appear in the Address Book (e.g., Cody, Catherine).
 - ↪ The Address Book sorts address entries alphabetically based on the first letter in the address name. Type the last name first if you want to find addresses for individuals by their last name.
4. In the Carrier field, press  left or right to scroll through the paging service providers. Highlight the name of your carrier, then press **TAB** or  down to move to the next field
 - ↪ If the paging carrier of the addressee is accessible from your paging carrier,  ! appears next to the Pager field. If the envelope does not appear, the Enter PIN field allows you to store the pager information for reference only.
5. In the Pager field, press  left or right to scroll through the pager types. Highlight the pager type, then press **TAB** or  down to move to the next field.
 - ↪  provides access to additional information about the PIN for the selected pager type.
6. Enter the individual's PIN and/or fax number.
7. Select **Next**  to access a supplemental screen where you can enter other address information, such as email address, home phone number, work phone number, and fax number.
8. Select **Next** , then type any additional information in the Notes text field.
9. Select **OK** to return to the Address Book Entries screen.

To add a group:

1. Select **Addresses**  from the menu wheel.
2. Select **New Group Entry**.
3. In the Group Name field, type the name for the group as it should appear in the Address Book (e.g., Sales Team), then select **Next**.
4. Select the individual members to add to the group.

TIP Press  up or down to highlight an address entry, then press  to select the entry.  appears next to each entry selected. Press  again to de-select an entry, as required. When you are finished selecting group members, press **TAB** to access the button field.



5. Select **OK** to accept the changes and return to the Address Book Entries screen.

Editing Addresses

Addresses saved in your Address Book can be updated as information changes. To update Address Book files from your personal computer (PC), review “FLEX PC Partner” on page 54, then see “Managing Your Address Book” on page 58.

TIP Type as many characters of the address name as you want to find the contact you are looking for. If the address cannot be found, the pager will beep and display an error message.

To edit an individual address:

1. Select **Addresses**  from the menu wheel.
2. Press  up or down to highlight the address entry requiring change then, select **Edit**.
3. Place the cursor in the field containing the information you want to change.



In text fields, press **BKSP** to delete old information, then type the new information.

-or-

In scrolling fields, press  left or right to scroll within the fields and highlight the correct information.

4. Select **OK** to return to the Address Book Entries screen.



To change the name of a group:





1. Select **Addresses**  from the menu wheel.
2. Press  up or down to highlight the name of the group you want to change, then select **Edit**.

TIP Press **TAB** to access the button field, then press  left or right to scroll through the options.

3. From the Group Addresses screen, select **EditName**.
4. From the Change Group Name screen, press **BKSP** to delete the current name, then type the new name.
5. Select **Next** then **OK** to accept the change and return to the group addresses screen.

To change the group's membership:

1. Select **Addresses**  from the menu wheel.
2. Press  up or down to highlight the name of the group to which you are adding or deleting members, then select **Edit**.
3. From the Choose Members screen, select the entries from the Address Book to add to or remove from the group's membership.

TIP Press  up or down to highlight an address entry, then press  to select the entry.  appears next to each entry selected. Press  again to de-select an entry, as required. When you are finished selecting group members, press **TAB** to access the button field.

TIP Remember! Deleting a member from a group will not delete the individual member's address from the Address Book. After deleting a member from a group address, delete the individual address, as needed. Addresses that are deleted are automatically removed from groups.

-
4. Select **OK** to accept the changes and return to the Address Book Entries screen.



Deleting Addresses

A well maintained Address Book provides quick access to the addresses you need. Delete addresses for individuals that you no longer contact or for groups that no longer exist.

TIP Remember! Deleting group addresses will not delete the individual member addresses. After deleting a group address, delete the individual addresses, as needed.

 The deletion of addresses cannot be undone.

To delete an address:

1. Select **Addresses**  from the menu wheel.
2. Press  up or down to highlight the Address Book entry, then select **Delete**.
3. Select **Yes** at the confirmation screen to delete the address and return to the Address Book Entries screen.

The Write application enables you to compose messages using the QWERTY keyboard, insert Quick Text, and append your signature. You can also choose to send your messages at a later time, file the messages in inboxes prior to sending, and even place reminder alerts on messages. When you send a new message, you return to the Home screen and the status of the message is displayed there. Messages can be sent to other Two-Way Wireless Communications Centers, two-way pagers, one-way pagers, email addresses, and fax numbers by selecting the appropriate address. See “Entering Addresses” on page 27 for more information on creating address entries.

Writing Messages

The QWERTY keyboard provides a familiar key layout, enabling you to quickly type and send your message. For information on Alt-mode keys and Symbols, see “Alt Functions” on page 11.

Thirteen symbols (colored *blue* on the keyboard) are available using the Alt mode. The number keys plus three other keys (⌘, ⌘, ⌘) are used by pressing (ALT), then the corresponding key.

1	+	2	_	3	=	4	“	5	<	6	>	7	[
8]	9	{	0	}	?	\	.	;	.	:		

For information on Shift-mode keys, see “Shift-mode Functions” on page 12.

Thirteen symbols (colored *white* on the keyboard) are available using the Shift mode. The number keys plus three other keys (⌘, ⌘, ⌘) are used by pressing (SHIFT), then the corresponding key.

1	!	2	@	3	#	4	\$	5	%	6	^	7	&
8	*	9	(0)	?	/	.	≤	.	-		





To write a message:

1. Select Write  from the menu wheel.
2. Type your message, then press (TAB) to access the button field.
3. Select Send To.

4. Select the recipient(s) from the Address Book list.

TIP Each recipient can have more than one entry. Select the recipient by the type of messaging device receiving the message (e.g., two-way pager, one-way pager, email, fax).

TIP Before sending messages to fax addresses, use the Customize application to record the Internet email address for your Internet fax service. Fax addresses will not show up in the 'Send To' list if they haven't entered an internet fax address.

TIP When selecting an entry, press  up or down to highlight an address entry, then press  to select the entry.  appears next to each entry selected. Press  again to deselect an entry, as required. When you are finished selecting recipients for your message, press **TAB** to access the button field. Select **Review** to see a short list of the addresses you had selected.

TIP Press  from the Address Book list to return to the message and continue editing.

5. Select to send your message.

Importing Messages

The Import feature enables you to use text from a message stored in one of your inboxes, as part of an outgoing message.



To import a message:

1. From the Compose Message screen, select to view the list of mailboxes.
2. Open the desired mailbox.
3. Open the existing message you want to use as the basis for your outgoing message.
4. Edit as necessary.
5. Send as you normally would: press **TAB** , select the recipient of the message, and then select .

Adding Quick Text

The Quick Text feature enables you to quickly add frequently used text to your messages. This saves time and key strokes when composing a message. See “Customizing Message Features” on page 50 for information on composing your own Quick Text through the Customize application.





To add Quick Text to your message:

1. From the Compose Message screen, select .
2. Press  up or down to highlight the desired text, then press . The Quick Text appears in your message on the Compose Message screen, ready for you to complete your message.

Attaching Message Replies

When sending a message to a two-way pager that returns canned text responses, your PageWriter 2000X Two-Way Wireless Communications Center allows you to provide a selection of replies to your message. Messages typed in the Replies fields will be available to the person receiving your message. Rather than selecting the canned messages available on their pager, they can select one of the customized replies you have provided.

To attach Replies to your message:

1. From the Compose Message screen, select .
2. Type your choices of replies in the numbered fields.
 Fields are provided for sixteen replies. Use  and  to access the additional fields.
3. Select  to attach the replies to your message when it transmits.

Saving Your Message to the Drafts Inbox

If a message comes in while composing a new message, you can save the message to the Drafts inbox and display the incoming message.





To save the current message to the Drafts inbox while receiving an incoming message:

1. From the Compose Message screen, answer Yes to exit screen and read it now.
2. Answer Yes to save current message to Drafts inbox and view incoming message.

Scheduling a Delayed Send

Messages can be composed at your convenience and then scheduled for automatic transmission later at the appropriate send time.

To schedule the transmission of a message:

1. From the Compose Message screen, select **Send To**.
2. Select the recipient(s) from the Address Book list.
3. Select **Delay**.
4. From the Time field, select the time when you want to send the message. Press  up or down in each field to change the hour, minute, or AM/PM. Press  right or left to move between Time fields.
5. Press **TAB** to access the Date field. Select the date when you want to send the message. Press  up or down to change the numbers for the date. Press  right or left to move between Date fields.
6. Select **OK** to accept the schedule.

Filing a Message Draft

Partial or unfinished messages can be stored for later edit and/or transmission. Saving your messages to an inbox avoids unnecessary text re-entry while allowing you to compose messages at your convenience.

Similarly, partial or unfinished messages can be saved in the Drafts inbox when an incoming message interrupts you. When a message in the Drafts inbox is opened, the Write application is launched (see “Saving Your Message to the Drafts Inbox” on page 33).







To file the draft of a message before transmission:

1. From the Compose Message screen, select **Import**.
2. Press  up or down to highlight the inbox to which you want to save your message draft, then select **File**. Your draft is saved to the inbox for edit or transmission at a later time.

Entering a One-Time Address

Occasionally, you may send a one-time e-mail message from your pager. For example, you want to send a demonstration e-mail message, but you'll never have a reason to send e-mail to this individual again. In such a situation, you don't want to *save* the individual's e-mail address, since it will only take up space on your pager.

To set a one-time address:

1. At the menu wheel, select , just as you ordinarily would to send a message.
2. At the Compose Message screen, enter the text of the e-mail message in the usual manner.
3. Select .
4. At the Choose Recipients screen, select New Address (it should be already highlighted).
5. At the New Address screen, press  to go directly to the Address Type field, *leaving the Name field blank*. This tells your pager not to save the information in the Address Book.
6. Press  left or right to select E-mail Address. Press  to move to the E-mail Address field.
7. Enter the individual's e-mail address just as you normally would.
8. Select . Note that at the Choose Recipients screen, the last item is the e-mail address you just entered, and it has a check mark next to it.
9. Select . The e-mail message will be transmitted, but nothing will be saved to your recipient list.

Read

The Read application enables you to read and respond to incoming messages, forward or file messages, and delete messages. It also allows you to manage the inboxes, folders, Outbox, and Trashcan accessible from the Message Area.



Reading Incoming Messages

Incoming messages can be read as they are received or held in the appropriate inbox to be read at a later time. The New Messages screen takes you directly to the new message, or you can access unread messages from the Message Area screen.

To read an incoming message:







Select at the New Messages announcement screen to display the message.

TIP The top of the Message screen displays the quantity of new messages waiting to be read (e.g., Message 1 of 4).

Press  down or up to scroll within the message text. Press  right or left to scroll between the messages.

↪ Messages that have already been read cannot be accessed from this list of new messages. Use the Read application to view previously read messages. See the next procedure for viewing messages from the Message Area screen.















To read a message from the Message Area screen:

1. Select  from the menu wheel.
2. Select the inbox containing the message.
 - ↪  indicates an inbox containing at least one unread message.
 -  indicates an inbox that contains only messages that have already been read.
3. Select the message.
 - ↪  indicates a new, unread message.
 -  indicates that you have already read the message.
 -  indicates messages with alarms.
4. Select to return to the Messages list, or press to return to the menu wheel.

Setting a Reminder Message Alarm

Send yourself a reminder for meetings, special events, and other important To Do's. Reminder messages can be sent once or on a regular basis (e.g., daily, weekly, monthly, yearly). When it's important that you remember, send yourself a reminder message on your PageWriter 2000X Two-Way Wireless Communications Center.

To set a reminder message alarm:



1. Select  from the menu wheel.
2. Type your reminder message, then select .
3. Press  up or down to highlight the folder to which you want to save your reminder message, then select .
4. From the Time field, select the time when you want the alarm to remind you. Press  up or down in each field to change the hour, minute, or AM/PM. Press  right or left to move between Time fields.
5. Press  to access the Date field. Select the date when you want the alarm to remind you. Press  up or down to change the numbers for the date. Press  right or left to move between Date fields.
6. Press  to access the alert frequency field. Press  up or down to highlight how often you want this message to remind you, then press .
7. Press  to access the button field, then select  to accept the schedule.
8. Select . At the scheduled time, your reminder message is sent to you.

Sending Responses

Responding to messages is quick using pager-provided (canned) text or the QWERTY keyboard.

To send a custom reply:

1. From the Message screen, select . The Custom response is highlighted at the top of list.

2. Press  and write your reply. Press **TAB** to send and press  to send your response.

To send a canned reply:

1. From the Message screen, select **Reply**.
2. Highlight one of the provided responses from the list.
3. Select **Send** to confirm that you want to send the desired response.

Forwarding Messages





Your PageWriter 2000X Two-Way Wireless Communications Center enables you to share your received messages without retyping them. Simply forward the message to an address in your Address Book. Your signature is appended to the beginning of the forwarded message.

To forward a message:

1. From the Message screen, select **Fwd. To**.

TIP Press **TAB** to access the button field, then  to scroll through the options.

2. Type a forwarding note if desired, then select **Send To**.
3. From the Choose Recipients screen, select the recipient(s), then select **Send**.

TIP When selecting an entry, press  up or down to highlight an address entry, then press  to select the entry.  appears next to each entry selected. Press  again to de-select an entry, as required. When you are finished selecting recipients for your message, press **TAB** to access the button field.



4. Select **Done** to return to the Messages list, or press **HOME** to return to the menu wheel.





Filing Messages

Messages that have been read can be saved to an inbox. For more information on creating inboxes, see “Inboxes” on page 40.

To save a message to an inbox:

1. From the Message screen, select .



TIP Press  to access the button field, then  to scroll through the options.

2. Press  up or down to highlight the inbox to which you want to save your message, then select .
3. Select  to return to the Messages list, or press  to return to the menu wheel.

Deleting Messages

Messages can be deleted from either the Messages list or the Message screen. Deleted messages are moved to the Trashcan, where they are permanently erased when the Trashcan is emptied. For more information, see “Trashcan” on page 46.

To delete a message from the Messages list:



From the Messages list, press  up or down to highlight the message you want to delete, then select . The message is deleted.

To delete a message from the open Message screen:

From the Message screen, select . The message is deleted.

Managing the Message Area

The Message Area contains three types of containers:

-  Inboxes
-  Outbox
-  Trashcan

Inboxes

Inboxes are containers that receive incoming messages transmitted to your PageWriter 2000X Two-Way Wireless Communications Center. Three types of inboxes automatically organize the messages for you: Main Inbox, information services, and personal.

The Main Inbox receives general messages that are sent to your pager. You can set message alerts and assign a cleanup schedule to help maintain the contents, however, the Main Inbox cannot be renamed, have routing rules assigned, nor be deleted.



↳ Routing rules are specific keywords or text strings that your PageWriter 2000X Two-Way Wireless Communications Center looks for in incoming messages. You can identify keywords or text strings for personal inboxes. When keywords or text strings are found, the message is placed in the appropriate inbox.



Information services inboxes receive subscriber messages, such as world news, financial updates, and sports scores. Information services inboxes can only be created, renamed, or deleted by the information service provider. Changing information service inboxes requires a software change that is completed over-the-air (OTA) or at a service center by the service provider.

Personal inboxes are inboxes that you can create to receive specific types of messages. Incoming messages are automatically routed to your personal inboxes based upon the routing rules you assigned for each inbox. The number of incoming messages is reported when you view the inbox. You can create, rename, or delete personal inboxes at any time.

To create a personal inbox:

1. Select  from the menu wheel.

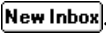
TIP Press  to access the button field, then  to scroll through the options.

2. Select .
3. Type the name of the new inbox in the name field.
4. Type specific keywords in *Get messages with* field that your pager will look for in incoming messages. Messages containing one or more of these strings will automatically be placed in this inbox.
5. Select  to accept the changes and return to the Message Area screen.

-or-

Select  to continue configuring the new inbox.

6. Press  left or right in each alert mode field to select the alerts.

TIP Press  to sample the alert.

7. Select  to accept the changes and return to the Message Area screen.

-or-

Select  to continue configuring the inbox.

8. Select the cleanup option:

No Cleanup ↵ Keeps all messages.

Number of Messages ↵ Keeps the most recent messages up to the number of messages indicated.





Age of Messages ↵ Keeps the messages that have been in the inbox fewer days than the number of days indicated.

9. If the automatic cleanup is selected, type the maximum number of days the message is retained in the inbox before it is deleted, or the maximum number of messages retained before the oldest message is deleted.



↵ Cleanup runs nightly deleting only read messages and those without alarms.

10. Select  to accept the changes and return to the Message Area screen.

To rename a personal inbox:

1. Select  from the menu wheel.
2. Press  up or down to highlight the inbox you want to rename, then select .
3. Press  to delete the current name, then type the new name.
4. Select  to accept the changes and return to the Message Area screen.

To assign routing rules:





1. Select  from the menu wheel.
2. Press  up or down to highlight the inbox requiring routing rules, then select .

3. Type specific keywords in *Get messages with* field that your pager will look for in incoming messages. Messages containing one or more of these text strings will automatically be placed in this inbox.

↵ Do not use the same text for more than one inbox.

4. Select **Done** to accept the changes and return to the Message Area screen.



To set the alert type for an inbox:

1. Select **Read**  from the menu wheel.
2. Press  up or down to highlight the inbox requiring a new alert type, then select **Customize**.
3. Select **Next**  from the Edit Inbox screen.
4. Press  left or right in each alert mode field to select the alerts.





TIP Press **ENTER** to sample the alert.

5. Select **Done** to accept the changes and return to the Message Area screen.

To clean up an inbox:

1. Select **Read**  from the menu wheel.
 2. Press  up or down to highlight the inbox you want to clean up and press **TAB**.
 3. Select **Cleanup**.
- ↵ Cleanup deletes only read messages and those without alarms.

To assign a cleanup schedule to an inbox:

1. Select **Read**  from the menu wheel.
2. Press  up or down to highlight the inbox requiring a cleanup schedule, then select **Customize**.
3. Select **Next**  from the Edit Inbox screen.
4. Select **Next**  from the Set Alerts screen.
5. Select the cleanup option:
 - No Cleanup** ↵ Keeps all messages.
 - Number of Messages** ↵ Keeps the most recent messages up

to the number of messages indicated.



Age of Messages ↵ Keeps the messages that have been in the inbox fewer days than the number of days indicated.

6. If the automatic cleanup is selected, type the maximum number of days the message is retained in the inbox before it is deleted, or the maximum number of messages retained before the oldest message is deleted.

↳ Cleanup runs nightly, deleting only read messages and those without alarms.

7. Select to accept the changes and return to the Message Area screen.



To delete a personal inbox:

1. Select  from the menu wheel.
2. Press  up or down to highlight the inbox you want to delete, then select .

TIP All unread or alarmed messages in an inbox must be read, deleted, or disabled before the inbox can be deleted.

3. Select at the confirmation screen to delete the inbox and return to the Message Area screen.

To view the messages in an inbox:

1. Select  from the menu wheel.
2. Press  up or down to highlight the inbox you want to view, then press . A list of messages appears.

↳  indicates messages with alarms.

3. Select the message you want to view.
4. Select to return to the Messages list, or press to return to the menu wheel.

Outbox







The Outbox serves two purposes. It provides a transmission status log for messages sent within the past day and acts as a holding area for unsent messages. All sent messages go into the Outbox and stay there until a scheduled cleanup of the Outbox takes place. The messages are categorized into six types. Select  to display the Outbox icon descriptions:

- »» Sending in progress
- ✓ Sent successfully
- △ Message in queue
- ⌘ Transmitter not on
- ⌚ Delayed send message
- ✕ Sending failed (with an alert)





Due to the message transmission process, the transmission status can alternate between **△ Message in queue** and **»» Sending in progress** before attaining **✓ Sent successfully** status (see "The Home Screen" special status icons).

When the status of one of the messages in the Outbox changes, the screen refreshes and the first item is highlighted.

To cancel outgoing messages in the Outbox:

1. Select  from the menu wheel.
2. Select  **Outbox**.
3. Press  up or down to highlight the unsent message you want to cancel, then select .
- ↳ Only unsent messages can be canceled.
4. Select  at the confirmation screen.
5. Select  to return to the Message Area screen, or press  to return to the menu wheel.

To resend messages from the Outbox:

1. Select  from the menu wheel.
2. Select  **Outbox**.
3. Press  up or down to highlight the message you want to resend.
4. Press  to access the button field, then select .

↩ Only messages that have already been sent (✓) or messages that failed to transmit (✗) can be resent.



5. Select **Exit** to return to the Message Area screen, or press **HOME** to return to the menu wheel.

To resend a failed message from the Outbox:





1. Open the Outbox.
2. Press  up or down to highlight the failed message you want to resend.
3. Press **TAB** to access the button field, then select **Resend** and **OK**.
4. Select **Exit** to return to the Message Area screen, or press **HOME** to return to the menu wheel.

TIP If for any reason the message fails to transmit, the system will present an automatically generated screen offering you to resend the message. Select **Yes** if you desire to do so.

To view message information:

1. Select **Read**  from the menu wheel.
2. Select  **Outbox**.
3. Press  up or down to highlight the message of interest, then select **Details**. The message, replies to the message, and the addresses the message and replies were sent to displays.
4. Select **Empty**.
5. Select **Exit** to return to the Message Area screen, or press **HOME** to return to the menu wheel.

To forward messages from the Outbox:





1. Select **Read**  from the menu wheel.
2. Select  **Outbox**.
3. Press  up or down to highlight the message you want to forward, then press .
4. Select **Forward**.

5. Type a note to accompany the message being forwarded, then select:
 - Send To** to forward to an address.
 - File It** to forward to an inbox.
6. Select the address to which the message will be sent, then select **Send**.
7. Select **Done**.
8. Select **Exit** to return to the Message Area screen, or press **HOME** to return to the menu wheel.



Trashcan

Messages can be restored from the Trashcan until the Trashcan is emptied. The Trashcan is emptied upon your request, when memory is running low, and each night. See “Memory Management System” on page 74 for more information.

To restore a message from the Trashcan:

1. Select **Read**  from the menu wheel.
2. Select  **Trashcan**.
3. Press  up or down to highlight the message you want to restore, then select **Restore**.
4. Press  up or down to highlight the inbox to which you want to move the message, then select **OK**.
5. Select **Exit** to return to the Message Area screen, or press **HOME** to return to the menu wheel.

To empty the Trashcan:



1. Select **Read**  from the menu wheel.
2. Select  **Trashcan**.
3. Select **Empty**.
4. Select **Yes** at the confirmation screen to delete the messages from the Trashcan.
5. Select **Exit** to return to the Message Area screen, or press **HOME** to return to the menu wheel.

The Customize application provides a variety of features that allow you to configure your PageWriter 2000X Two-Way Wireless Communications Center to suit your needs.





Viewing System Status

Information available through the Customize application includes system information, memory usage, and owner information.

To view system information:

1. Select  from the menu wheel.
2. Select **About PageWriter** to view version, model, and operating system information. A list of applications is also provided.
3. Select  to return to the Customize screen, or press  to return to the menu wheel.



To view memory usage:

1. Select  from the menu wheel.
2. Select **Memory Usage** to view summary of the amount of memory in use by various elements.
3. Select  to return to the Customize screen, or  to view more detail about current and total memory usage, or press  to return to the menu wheel.

To view owner information:

1. Select  from the menu wheel.
2. Select **Owner Information** to view your information.





TIP The information on this screen can be edited. Simply delete any existing information and type the new information.

3. Select  to accept any changes to the owner information and return to the Customize screen, or press  to return to the menu wheel and discard any changes.





Enabling and Disabling Alerts and Alarms

The Unread Message Alert feature indicates that you have messages that were not read at the time they arrived and continue to be unread. Using the same alerts you selected for the inbox receiving the message, the Customize application allows you to turn on or off the Unread Message Alert feature, as well as the LED alarms.

To enable/disable the unread message alert:

1. Select  from the menu wheel.
2. Press  up or down to highlight **Unread Msg Alert**, then press  or **ENTER** to toggle between [Now ON] and [Now OFF].
3. Select  to return to the Customize screen.



To enable/disable LED alarms:

1. Select  from the menu wheel.
2. Press  up or down to highlight **LED Alarms**, then press  or **ENTER** to toggle between [Now ON] and [Now OFF].
3. Select  to return to the Customize screen.

Setting Up Internet Fax Service

Before you can send fax messages you must first identify the email address of the Internet fax service you intend to use. Through the Customize application, record the email address of your Internet fax service. If you make a change, your pager restarts so the change takes effect. When you are ready to send a fax, simply select the fax address from the Address Book for the person you want to contact.





To set up an Internet fax service:

1. Select  from the menu wheel.
2. Select **Internet Fax Service**.
3. Type the email address for the fax service.
 Do not enter the fax number or “@” sign.
4. Select  to return to the Customize screen.





Customizing the User Interface

The Customize application enables you to adjust your PageWriter 2000X Two-Way Wireless Communications Center to reflect your preferences. Adjust the contrast level and message text size, select the date and time formats, and even turn off or on the key clicks.



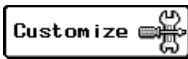

To use the contrast calibration guide:

1. Select  from the menu wheel.
2. Select **Contrast Help** to display Calibration Guide.
3. Press , then hold down . Watch the Calibration Guide to see how the shades of black, gray, and white are affected by your contrast selection.
4. Continue holding  down. The contrast adjustment will automatically reverse when it reaches extreme light and extreme dark contrasts. Release  when the desired contrast level is reached.



To select message text size:

1. Select  from the menu wheel.
2. Press  up or down to highlight **Message Text**, then press  or  to toggle between:
[Now NORMAL] ↵ Displays all message text in the standard font size.
[Now LARGE] ↵ Displays all message text in a larger font size.
3. Select  to accept the changes and return to the Customize screen.



To select the date format:

1. Select  from the menu wheel.
2. Press  up or down to highlight **Date Format**, then press  or  to cycle between:
[Now DD/MM/YY] ↵ Displays day/month/year format.
[Now YY/MM/DD] ↵ Displays year/month/day format.
[Now MM/DD/YY] ↵ Displays month/day/year format.
3. Select  to accept the change and return to the Customize screen.

To select the time format:

1. Select **Customize**  from the menu wheel.
2. Press  up or down to highlight **Time Format**, then press  or **ENTER** to toggle between **[Now AM/PM]** and **[Now 24 hr]**.
3. Select **Done** to accept the change and return to the Customize screen.

To turn on/off the key clicks:

1. Select **Customize**  from the menu wheel.
2. Press  up or down to highlight **Key Clicks**, then press  or **ENTER** to toggle between **[Now ON]** and **[Now OFF]**.
3. Select **Done** to accept the change and return to the Customize screen.

Customizing Message Features

Your PageWriter 2000X Two-Way Wireless Communications Center's messaging features enable you to:

- Create a signature for your messages then automatically append the signature to each message you send.
- Create and store frequently used text for inclusion in future messages.

To create a signature:

1. Select **Customize**  from the menu wheel.
2. Select **Send Options**.
3. Select the Signature text box, then type your message signature.
4. Select **OK** to accept the change and return to the Customize screen.

To automatically append your signature to each message you originate:



1. Select **Customize**  from the menu wheel.
2. Select **Send Options**.

↵ To save air time your signature is not already appended to replied messages.







3. Select **Add Signature when sent** (check appears in box).

Messages can be saved to an inbox on an individual basis. All your outgoing messages are saved to the Outbox.

To create Quick Text:

1. Select  from the menu wheel.
2. Select **Edit Quick Text**.
3. Select **Add New Quick Text**.
4. Type your Quick Text message of up to 100 characters.
5. Select  to accept the change and return to the Quick Text screen.
6. Select  to return to the Customize screen.



To edit Quick Text:



1. Select  from the menu wheel.
2. Select **Edit Quick Text**.
3. Press  up or down to highlight the text requiring changes, then select .
4. Press  to delete existing text, then type your new message.
5. Select  to accept the change and return to the Quick Text screen.
6. Select  to return to the Customize screen.

Quiet Time

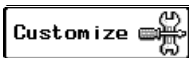
The Quiet Time feature lets you specify a daily time period during which message alerts will not be played without modifying the individual alert settings.

To set quiet time:

1. Select  from the menu wheel.
2. Select **Quiet Time Settings**. The Quiet Time Settings screen appears.
3. The On/Off switch is highlighted. Press  left or right to switch the setting between On and Off.
4. Press  to move to the hour in the Start Time field.



5. Press  up or down to set the hour.
6. Press **TAB** to move to the minute in the Start Time field.
7. Press  up or down to set the minute.
8. Press **TAB** to move to the AM/PM field in the Start Time field.
Press  up or down to select AM or PM.
9. Repeat Steps 4 through 6 for the End Time.
10. Select **Save** to save the settings.

Message alerts will not be played during the time you set as Quiet Time.

Maintaining Inboxes and Applications



Maintenance features such as Cleanup and Delete Applications enable you to remove unwanted messages or applications from your pager. To schedule the cleanup feature, see “To assign a cleanup schedule to an inbox:” on page 42.

To clean up all inboxes:

1. Select **Customize**  from the menu wheel.
2. Select **Cleanup**.
3. Select the containers to be cleaned:
 - All**  Deletes all read messages stored in inboxes that have no alarms set.
 - Inboxes**  Deletes all read messages stored in inboxes.

 Messages deleted in the cleanup process are not stored in the Trashcan. They are permanently deleted and cannot be recovered.
4. Select **Done** to delete the messages and return to the Customize screen.











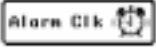

To delete applications:

1. Select **Customize**  from the menu wheel.
2. Select **Delete Applications**.
3. Press  up or down to highlight the application requiring deletion, then select **Delete**.
4. Select **Yes** at the confirmation screen to delete the application and return to the Customize screen.

Setting the Alarm Clock

Set an audible or vibrating alert at up to three preset times. These alarm clock alerts have no messages attached to them.

To set an alarm:

1. From the menu wheel, select . The Alarm Clock screen has three tabs that enable you to set three different alarms.
2. Press  left or right, or **TAB** to select Alarm 1, Alarm 2, or Alarm 3.
3. Press  down to move to the On/Off switch. Press  left or right to select On or Off.
 A bell icon () on an alarm's tab indicates that the alarm is on. A bell icon also displays on the status line of the menu wheel screen when an alarm is set.
4. Press **TAB** to move to the Frequency field. Press  left or right to select how often you want the alarm to go off. Your options are Once, Weekends, Weekdays, or Every day.
If you didn't select a frequency of Once, skip to Step 6.
5. If you selected Once, a Date field becomes active just below the Frequency field. Press **TAB** to move to the Date field. Press  left or right to change the date (one day at a time).
6. Press **TAB** to move to the hour in the Time field.
7. Press  up or down to change the hour.
8. Press **TAB** to move to the minute in the Time field.
9. Press  up or down to change the minute.
10. Press **TAB** to move to AM/PM in the Time field.
11. Press  up or down to select AM or PM.
12. Press **TAB** to move to the Alert field. Press  left or right to select the type of alarm you want (audible, vibrate, etc.).
13. To set other alarm times, repeat for the second and third alarm tabs.
14. Select **Done** to save the settings and return to the menu wheel.

Introducing FLEX PC Partner

The FLEX[®] PC Partner application enables you to transfer information between your personal computer (PC) and your PageWriter 2000X Two-Way Wireless Communications Center. The application enables you to manage the following common information management tasks:

- Adding information to your Address Book on your PC, then updating the Address Book on your pager
- Copying information from your pager to your PC (as a backup or for editing purposes)
- Copying information from your PC to your pager
- Printing all messages stored on your pager
- Copying all messages stored on your pager to your PC
- Installing a new application on your pager
- Updating the operating system on your pager

The FLEX PC Partner application handles the various information transfers and related operations with small component programs. The Partner applets, or *partlets*, are accessed from a control panel known as the *Shell*.

PC Hardware Requirements

In order to connect properly with your pager, your PC must meet the following minimum requirements:

- IBM-compatible 486SX 66 MHz processor or greater
- 16 MB RAM
- 7 MB of available storage on the computer's hard drive
- VGA monitor with 640x480 resolution
- PageWriter 2000X Two-Way Wireless Communications Center docking station to supply infrared connection (provided with the unit)

PC Software Requirements

Windows 95, 98 or NT must already be installed on your PC.

FLEX PC Partner Online Help

Online Help is accessible by pressing **F1** on your PC keyboard at any time while in the FLEX PC Partner application. Clicking the Help button on a FLEX PC Partner dialog box brings up context-specific help.

Installing FLEX PC Partner on Your PC

The FLEX PC Partner application includes a setup program that automatically copies the program files to the appropriate folders on your PC. Setup creates the folders for you if they don't already exist.



To install FLEX PC Partner on your PC:

1. Insert *FLEX PC Partner Disk* into the disk drive on your PC.
2. From the Windows taskbar, click **Start**, then **Run**.
3. Select or type **A:\SETUP.EXE**. (If the disk is in a drive other than A:, substitute the appropriate drive letter.) Press **Enter**.
4. Follow the prompts. Typically, you will want to accept the option on each screen that Setup has already selected (the default).
5. When Setup is complete, click **OK** at each information window.
6. Click **Yes** to read the Release Notes. They contain important information that might not have made it into the documentation. Close the Release Notes before continuing.
7. Select  **FLEX PC Partner** to start the PC Partner Shell.

Linking Your PageWriter 2000X Pager to Your PC

The connection that enables your pager and your PC to exchange information is a combination of an infrared (IR) link and direct cabling. The Deluxe charger, or *docking station*, has a built-in IR port. When you snap your pager into the docking station the IR port on your pager aligns with the IR port on the docking station. The docking station is connected to one of your PC's serial ports via the Motorola-supplied RS232 null modem cable. The LED on your pager flashes RED and GREEN indicating IR communication between the PC and your pager.



To establish a connection between your pager and FLEX PC Partner on your PC:

1. Snap your pager into the docking station. For information on connecting the docking station to your PC, see “The Infrared Port” on page 17.
2. On your pager, select  from the menu wheel.
3. Select .
4. If this is the first time the FLEX PC Partner application is being installed on your PC continue to the next section, "Configuring FLEX PC Partner". Otherwise, see “Using the PC Partner Shell” on page 57.

Configuring FLEX PC Partner

The FLEX PC Partner Configuration utility is run immediately after installing FLEX PC Partner. It tells the FLEX PC Partner application how your pager will be connecting to your PC. If you change hardware (e.g., replace the charger with a new type of charger) reconfigure the FLEX PC Partner application using the following procedure.

To configure FLEX PC Partner:

1. From your desktop, double-click  **FLEX PC Partner**.
-or-
From the Windows 95 taskbar, click **Start**, then point to **FLEX PC Partner** and click  **FLEX PC Partner**.
2. From the PC Partner Shell, double-click  **Partner Configuration**.
3. From the FLEX PC Partner Configuration dialog box, select the appropriate serial port.
↳ If the port selection is not correct, an error message appears (“No IR devices found”).
4. In the Adapter list box, select the appropriate adapter.
5. Click **OK**. If this is not the first time FLEX PC Partner has been configured to your PC, click **Yes** to save your choices and close the FLEX PC Partner Configuration partlet.

Using the PC Partner Shell

The FLEX PC Partner application consists of individual component applications accessible from the FLEX PC Partner Shell, known as partlets. Since each partlet operates independently, they can be used in any order. Except as noted below, you must establish a connection between your pager and your PC in order to open a partlet.

The following partlets are currently available:

- Address Book (does not require connection to pager)
- Memory Usage
- Message Manager (does not require connection to pager)
- Backup Utility
- Restore Utility
- Application Manager
- Partner Configuration

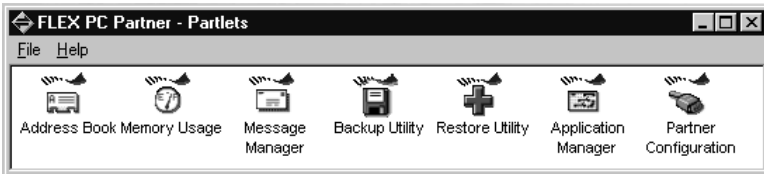

To open the FLEX PC Partner Shell:

From your desktop, double-click  **FLEX PC Partner**.

-or-

From the Windows 95 taskbar, click **Start**, then point to **FLEX PC Partner** and click  **FLEX PC Partner**.

To open a FLEX PC Partner partlet from the Shell:

1. Double-click the partlet's icon.

TIP Right-clicking an icon also displays a pop-up menu you can use to open a partlet.

2. If the FLEX PC Partner Connect dialog box appears, click **Connect**.

To determine a partlet's version:

1. From the FLEX PC Partner Shell, click the partlet's icon.
2. From the File menu, click **Properties**. The partlet's version number displays.

TIP Right-clicking an icon also displays the File menu.

Managing Your Address Book

The FLEX PC Partner Address Book enables you to transfer the Address Book information from your PageWriter 2000X Two-Way Wireless Communications Center to your PC. You can then conveniently view and edit name and address information on your PC and send the revised information back to your pager.

Address Book management includes:

- Transferring Address Book information between your pager and your PC
- Managing your Address Book files on your PC
- Managing Address Book entries for individuals
- Managing Address Book entries for groups
- Printing Address Book information



Transferring Address Book Information

The FLEX PC Partner application enables you to transfer your Address Book information from your pager to your PC where it can be easily edited or stored as a backup file. Edited Address Book files should be transferred back to your pager to synchronize your PC and pager Address Books.

↪ Files saved to your PC use an .ADR extension. Information in .ADR files can be edited through the FLEX PC Partner Address Book partlet.

↪ The amount of RAM in your pager is always checked when you connect it to the PC. If the RAM is low, a message on the pager warning of the low RAM condition displays, asking if you want to reset your pager to free up used space in RAM. If you select Yes, the pager restarts. If you select No, your pager automatically exits the PC Partner application.

To transfer your Address Book information from your pager to your PC:

1. Snap your pager into the docking station.
2. On your pager, select  from the menu wheel, then select  and wait for the Connection Status screen:



Paging functions are temporarily suspended while your pager is connected to your PC. Incoming messages will be retained by the paging service provider until your pager is disconnected from your PC.

3. On your PC, open the FLEX PC Partner Shell, then double-click



Address Book.

4. Click , or from the File menu, click **Get From Pager**.
5. Click **Connect**. Status messages on your PC screen notify you of the progress of the transfer. When the transfer is complete, the Address Book is updated on your PC.





You can now add, edit, or delete Address Book information on your PC. After editing Address Book information on your PC, you can save it to a file on your PC or send the information back to your pager to update the Address Book on your pager.

TIP When you select Get From Pager, the currently open Address Book on your PC is replaced by the Address Book being transferred from your pager. Before transferring the file, save the Address Book on your PC to another file name.



TIP To merge Address Books, ensure the Address Books are saved as separate .ADR file names, then merge them using the Import/Merge menu command. See “To merge two Address Book files on your PC:” on page 62 for instructions on merging two Address Book files.

6. Click , or from the File menu, click **Save**.
7. Select the file location, type the name for the new Address Book file, then click **Save**.

To transfer your Address Book information from your PC to your pager:

1. Snap your pager into the docking station.
2. On your pager, select  from the menu wheel, then select  and wait for the Connection Status screen.
3. On your PC, open the FLEX PC Partner Shell, then double-click  **Address Book**.
4. Click , or from the File menu, click **Open**.
5. Select or type the name of the .ADR file you want to transfer, then click **Open**.
6. Click , or from the File menu, click **Send To Pager**.
7. Click **Connect**. Status messages on your PC screen notify you of the progress of the transfer.

TIP If you have made changes to the Address Book on your pager that are not included in the Address Book on your PC and you do not want to lose the changes, transfer the Address Book on your pager to your PC. Save the file to a different .ADR name, then merge the file with the Address Book on your PC. Send the final merged Address Book to your pager.

8. On your pager, select .
- ↪ Your paging functions are suspended while a connection exists between your pager and PC. When you have finished transferring data, select  to re-enable the send and receive functions.



Managing Address Book Files

Managing your Address Book files comprises creating, saving, opening, merging, importing and deleting the files.

↳ Your pager does not need to be connected to your PC to perform the following procedures, unless noted otherwise.

TIP Delete .ADR files that you no longer need.

To create an Address Book file on your PC:

1. On your PC, open the FLEX PC Partner Shell, then double-click  **Address Book**.
2. Click , or from the File menu, click **New**. If an existing Address Book file is open, FLEX PC Partner prompts you to save your changes before closing it.
3. A blank Address Book appears, ready for you to enter new addresses and create new groups.
4. Upon completing entries in your new Address Book, click , or select the File menu, then click **Save**.
5. Select the file location, type the name for the new Address Book file, then click **Save**.

To save an open Address Book file on your PC:



With the Address Book file open, click , or from the File menu, click **Save**.

If this Address Book file has not been saved already, FLEX PC Partner prompts you for a file name. Type the file name, then click **OK**.



To save an open Address Book file under a new name:

1. From the File menu, click **Save As**.
 2. Select the file location, type the new name for the Address Book file, then click **Save**.
- ↳ You do not need to type the file extension. The FLEX PC Partner application automatically appends the .ADR default extension.



To open an Address Book file on your PC:

1. On your PC, open the FLEX PC Partner Shell, then double-click  **Address Book**.
2. Click , or from the File menu, click **Open**.
3. Select the Address Book (.ADR) file you want to open, then click **Open**. Once the desired Address Book file is open, you can add, edit, or delete address entries or group entries.



To merge two Address Book files on your PC:

1. On your PC, open the FLEX PC Partner Shell, then double-click  **Address Book**.
2. Click , or from the File menu, click **Open**.
3. Select the Address Book (.ADR) file you want to open, then click **Open**.

TIP The second Address Book file you select will merge into the first Address Book file. You might want to save a copy of the first file prior to performing the merge.

-  The Import/Merge command does not merge Address Book groups.
4. From the File menu, click **Import/Merge**.
 5. Select or type the name of the second Address Book file to be merged, then click **Open**.
 6. Click , or from the File menu, click **Save**.

To import Address Books from other PC-based applications:

1. On your PC, open the FLEX PC Partner Shell, then double-click  **Address Book**.
 2. From the File menu, click **Import/Merge**.
-  This menu command merges files into the currently open Address Book file.
3. Select or type the name of the file to be merged into the Address Book, then click **Open**.

↪ The Import/Merge command does not merge Address Book groups.

TIP Import/Merge supports .CSV, .VCF, and .ADR files for merging. You may import files that are of the same format as those created by the Export command on the File menu. You can edit the file with any editor to create the comma delimited file. There are database and spreadsheet programs that use comma-delimited text and will make the job easier should you have many addresses to convert. The format of a comma delimited text file is shown below.

```
"PersonName","PagerType","PagerPIN","Fax","Home-Phone","WorkPhone","Email","Notes"
```

For example:

```
"John","SkyTel Two Way","7388281","","","",  
"smith@5617383281","","",
```

Note that fields that you don't have information for may be skipped by adding "". After your address book data has been converted into this format, use the Partner Address Book and select File/ImportMerge and navigate to the .csv file that you created, and select it. The file will be opened and displayed in the Partner Address Book application.

4. Click , or from the File menu, click **Save**.

To delete an Address Book file from your PC:

From Windows Explorer or File Manager, highlight the .ADR file you want to delete, then press .



Managing Addresses of Individuals

Use the Individual menu on the Address Book main screen to add, edit, or delete individuals.

↪ Your pager does not need to be connected to your PC to perform the following procedures.

↪ Remember! Performing the following procedures affects only the Address Book on your PC. To update the Address Book on your pager, see "Transferring Address Book Information" on page 58.



To add an individual to the Address Book on your PC:

1. On your PC, open the FLEX PC Partner Shell, then double-click  **Address Book**.
2. Open the appropriate Address Book file. For more information, see “Managing Address Book Files” on page 61 for instructions on opening a file.
3. Click , or from the Individual menu, click **New**.
4. In the Name field, type the name for the entry as it should appear in the Address Book (e.g., Cody, Catherine).

TIP The Address Book sorts address entries alphabetically based on the first letter in the address name. Type the last name first if you want to find addresses for individuals by their last name.

5. In the Pager Type field, select the pager type.
6. Type the individual’s PIN for their pager.
 - ↳ The label and carrier-specific PIN entry instructions for this field are determined by the selected pager type.
7. Type other address information, such as fax number, home phone number, work phone number, email address, or your personal notes.
8. Click **OK**.
9. The new entry appears in the address list.
 - ↳  indicates the address is for an individual. Information for the highlighted entry appears below the address list.

To edit an individual's information in the Address Book on your PC:

1. On your PC, open the FLEX PC Partner Shell, then double-click  **Address Book**.
2. Open the appropriate Address Book file. For more information, see “Managing Address Book Files” on page 61” for instructions on opening a file.
3. Highlight the entry you want to edit, then click , or from the Individual menu, click **Edit**.



4. Edit the individual's information.

TIP Use the arrow keys to move the cursor *within* a field in the upper pane. Use  to move the cursor *between* fields.

↪ The Notes field holds up to 100 characters. Once you have reached the 100-character limit, existing characters must be deleted before more characters can be added.

5. Click **OK**.

To delete an individual from the Address Book on your PC:

1. On your PC, open the FLEX PC Partner Shell, then double-click  **Address Book**.
2. Open the appropriate Address Book file. For more information, see “Managing Address Book Files” on page 61” for instructions on opening a file.
3. Highlight the entry you want to delete, then click , or from the Individual menu, click **Delete**.
4. Click **Yes** at the confirmation screen.

Managing Addresses of Groups

A group address is a collection of individual addresses associated to one name in your Address Book. When you send a message to a group, the message goes to all members of the group without having to select each member individually. An individual in your Address Book can be a member of several groups.

Use the Group menu on the Address Book main screen to add, edit, or delete groups.

↪ Your pager does not need to be connected to your PC to perform the following procedures.

↪ Remember! Performing the following procedures affects only the Address Book on your PC. To update the Address Book on your pager, see “Transferring Address Book Information” on page 58.

To add a group to the Address Book on your PC:

1. On your PC, open the FLEX PC Partner Shell, then double-click  **Address Book**.
2. Open the appropriate Address Book file. For more information, see “Managing Address Book Files” on page 61” for instructions on opening a file.

3. Click , or from the Group menu, click **New**.
4. In the Group Name field, type the name for the group as it should appear in the Address Book (e.g., Sales Team).

TIP You can force address names to appear in a position in the Address Book that you find convenient. For example, prefacing group names with a space forces all the groups to appear at the top of the list. Using an underscore instead forces the names to the bottom of the list.



5. In the Available Addresses list on the left, select the addresses you want to add to the group, then click **Add**. The selected addresses appear in the Group Members list on the right.

TIP To select a series of addresses, highlight the first address, hold down **Shift**, then left click the mouse button on the last address. To select multiple addresses that are not in a series, highlight the first address, hold down **Ctrl** while you left click the mouse button on each additional address.

6. When you have finished adding all the addresses for this group, click **OK**. The new group appears in the address list on the Address Book main screen.

➔  indicates the address is for a group. The addresses assigned to this group are listed below the address list.

To add addresses to a group in the Address Book on your PC:



1. On your PC, open the FLEX PC Partner Shell, then double-click  **Address Book**.
2. Open the appropriate Address Book file. For more information, see “Managing Address Book Files” on page 61 for instructions on opening a file.
3. Highlight the group you want to edit, then click , or from the Group menu, click **Edit**.

4. In the Available Addresses list, select the address(es) to be added.



TIP To select a series of addresses, highlight the first address, hold down **[Shift]**, then left click the mouse button on the last address. To select multiple addresses that are not in a series, highlight the first address, hold down **[Ctrl]** while you left click the mouse button on each additional address.

5. Click **Add**.
6. Click **OK**.

To remove addresses from a group in the Address Book on your PC:

1. On your PC, open the FLEX PC Partner Shell, then double-click  **Address Book**.
2. Open the appropriate Address Book file. For more information, see “Managing Address Book Files” on page 61 for instructions on opening a file.
3. Highlight the name of the group you want to remove addresses from, then click , or from the Individual menu, click **Edit**.
4. In the Group Members list, select the address(es) to be removed.
5. Click **Remove**.
6. Click **OK**.

To delete a group from the Address Book on your PC:

1. On your PC, open the FLEX PC Partner Shell, then double-click  **Address Book**.
 2. Open the appropriate Address Book file. For more information, see “Managing Address Book Files” on page 61 for instructions on opening a file.
 3. Highlight the name of the group you want to delete.
 4. Click , or from the Group menu, click **Delete**, or press **[Del]**.
 5. Click **Yes** at the confirmation screen to delete the group.
- ↳ This procedure deletes only the group name. It does not delete the individual members of the group. To delete the individual members, see “Managing Addresses of Individuals” on page 63.

Printing Address Book Information

The FLEX PC Partner application enables you to check or reset the printer setting, then preview the printed Address Book information prior to printing the selection.



To set up a FLEX PC Partner printer:

1. On your PC, open the FLEX PC Partner Shell, then double-click  **Address Book**.
2. Open an Address Book file. For more information, see “Managing Address Book Files” on page 61 for instructions on opening a file.
3. From the File menu, click **Print Setup**.
4. In the Print Setup dialog box, select the appropriate printer settings. For more information, see your printer’s user’s manual.
5. Click **OK**.

To preview your printed Address Book information:

1. On your PC, open the FLEX PC Partner Shell, then double-click  **Address Book**.
2. Open the Address Book file you want to view. For more information, see “Managing Address Book Files” on page 61 for instructions on opening a file.
3. From the File menu, click **Print Preview**. For more information, see your printer’s user’s manual.
4. Click **Close** to close the preview window.





To print your Address Book information:

1. On your PC, open the FLEX PC Partner Shell, then double-click  **Address Book**.
2. Open the Address Book file you want to print. For more information, see “Managing Address Book Files” on page 61 for instructions on opening a file.
3. Click , or from the File menu, click **Print**.
4. In the Print dialog box, select the appropriate settings. For more information, see your printer’s user’s manual.
5. Click **OK**.

Managing Your Messages

FLEX PC Partner's Message Manager partlet transfers messages from your pager to your PC so you can view, print, copy, or store the messages on your PC.



To transfer messages from your pager to your PC:

1. Snap your pager into the docking station.
2. On your pager, select  from the menu wheel, then select  and wait for the Connection Status screen.
3. On your PC, open the FLEX PC Partner Shell, then double-click  **Message Manager**.
4. Click , or from the File menu, click **Get Messages From Pager**.
5. Click **Connect**.



The text on the status bar reflects the progress of the transfer as the messages are retrieved from your pager. When the transfer is complete, the status bar displays Ready, and the retrieved messages appear on the screen.

6. Click , or from the File menu, click **Save As**.
7. Select the file location, type the name for the message file, then click **Save**.

To read messages previously stored on your PC:

1. On your PC, open the FLEX PC Partner Shell, then double-click  **Message Manager**.
2. Click , or from the File menu, click **Open**.
3. Select the message (.PWM) file, then click **Open**.

To print messages:

1. Transfer from your pager to your PC the messages you want to print. For more information, see "To transfer messages from your pager to your PC:" on page 69.
 2. Click , or from the File menu, click **Print**. The messages print using your default printer settings.
-  Print Setup enables you to change printer options. For more information, see your printer's user's manual.

To copy text from a message to another PC application:

1. Transfer the messages from your pager to your PC. For more information, see “To transfer messages from your pager to your PC:” on page 69.
 2. In the Folder list, select the folder in which the desired message is stored.
 3. In the Messages list, select the desired message.
 4. In the Message Text pane, highlight the text you want to copy.
 5. Click , or from the Edit menu, click **Copy**.
 6. Start the application into which you want to paste the text.
 7. Position the cursor where you want to paste the text.
 8. From the Edit menu, click **Paste** to paste the message text at the location of the cursor.
- ↖ Text cannot be pasted into or deleted from an existing message.

To save messages to your PC:

1. Transfer the messages from your pager to your PC. For more information, see “To transfer messages from your pager to your PC:” on page 69.
2. In the Folder list, select the folder in which the desired message is stored.
3. In the Messages list, select the desired message.
4. Click , or from the File menu, click Save As.
5. Select the file location, type the file name for the message(s) to be saved, then click Save.



Installing and Removing Applications

FLEX PC Partner’s Application Manager enables you to add new applications to your PageWriter 2000X Two-Way Wireless Communications Center, or to remove applications that you no longer use. It also displays the authentication code of any applications installed on your pager.



TIP Before adding or removing applications from your PageWriter 2000X Two-Way Wireless Communications Center, perform a backup of the data.

To install a new application on your pager:

1. Snap your pager into the docking station.

2. On your pager, select  from the menu wheel, then select  and wait for the Connection Status screen.
3. On your PC, open the FLEX PC Partner Shell, then double-click  **Application Manager**.
4. Click **Connect**.
5. If the new application is on a diskette, insert the diskette into the appropriate diskette drive.
6. Click **Install New Application**.
7. Select the application file to be installed.
8. Click **Open**. A message appears when the installation is complete, and the new application is included in the list on the Application Manager.
9. Click **Exit**.

To remove an application from your pager:

1. Snap your pager into the docking station.
2. On your pager, select  from the menu wheel, then select  and wait for the Connection Status screen.
3. On your PC, open the FLEX PC Partner Shell, then double-click  **Application Manager**.
4. Select the application to be removed, then click **Remove Application**.
- ↳ Core applications cannot be removed.
5. Click **Exit**.



Backing-up and Restoring Information

The FLEX PC Partner Backup partlet enables you to copy the data from your pager to your PC. The data that is backed up includes your messages, your Address Book information, and your pager's applications.

Use the Restore partlet to copy your pager data stored on your PC back to your pager.



Caution! The Restore operation overwrites any existing data on your pager.

To copy data from your pager to your PC for backup:

1. Snap your pager into the charger.
2. On your pager, select  from the menu wheel, then select  and wait for the Connection Status screen.
3. On your PC, open the FLEX PC Partner Shell, then double-click  **Backup Utility**.
4. At the initial screen, click **Next**.
5. At the Select Backup File screen, select a destination for the file containing the saved information, then click **Next**.
 - ↪ A default FLEX PC Partner folder is provided, however, you can change its filename and location.
6. Click **Connect** to start the backup.
- ↪ File transfer may take several minutes, depending upon how much data you have on your pager.
7. At the success screen, click **OK** to close FLEX PC Partner and drop the connection to your pager.

To restore data to your pager from your PC:

Caution! **DO NOT** use the **PC Partner Restore Utility** to migrate your data from your PageWriter 2000 Smart Pager to your PageWriter 2000X Two-Way Wireless Communications Center. Use only the **System Maintenance Utility**, the **PC Partner Backup Utility**, and the instructions on page 21 to perform this operation.

1. Snap your pager into the docking station.
2. On your pager, select  from the menu wheel, then select  and wait for the Connection Status screen.
3. On your PC, open the FLEX PC Partner Shell, then double-click  **Restore Utility**.
4. At the initial screen, click **Next**.
5. At the Select Backup File screen, select the file containing the saved information you want to restore to your pager, then click **Next**.

6. Click **Connect** to start the restore.

Caution! All data on your pager (saved messages, Address Book entries, and applications) is deleted and replaced by the version of the data that was restored from your PC. This means that if you made changes to your Address Book on your pager after the last backup to your PC, you will lose those changes during this restore.



7. When the confirmation message appears, click **OK**.

Checking Memory Usage on Your PageWriter 2000X

The FLEX PC Partner Memory Usage partlet enables you to monitor the allocation of persistent storage on your pager. When the Memory Usage partlet indicates that the free memory on your pager is getting low, you can increase the free memory level by deleting old messages or applications.

↳ The memory usage levels refer to *persistent flash storage* (analogous to the hard drive on your PC) rather than *volatile memory* (RAM). The Memory Usage partlet does not monitor RAM.

To check memory usage on your pager:

1. Snap your pager into the charger.
2. On your pager, select  from the menu wheel, then select  and wait for the Connection Status screen.
3. On your PC, open the FLEX PC Partner Shell, double-click



Memory Usage.

TIP If you add or delete information from your pager while Memory Usage is open, click Refresh to update the memory usage information.

4. Click **Exit**.

Uninstalling FLEX PC Partner

1. From the Windows taskbar, click **Start**, then point to **FLEX PC Partner** and click  **Uninstall FLEX PC Partner**.
2. Click **Yes** at the confirmation screen to delete FLEX PC Partner and all of its components.

Memory Management System

The PageWriter 2000X Two-Way Wireless Communications Center internal memory management system automatically performs maintenance tasks. These tasks ensure sufficient memory is available to receive incoming messages and to support your processing requirements. To maximize memory efficiency, messages are deleted in the following order:

- ↳ Messages deleted during the cleanup process are not moved to the Trashcan; they are permanently deleted.
- ↳ Unread and alarmed messages are deleted from inboxes that contain 250 messages or if the Number of Messages cleanup option is selected and the limit for the number of messages has been reached.

Trashcan — Automatically configured to empty each night at midnight (you may specify the cleanup of inboxes and the Outbox, as well); midnight cleanup deletes messages placed in the Trashcan 24 to 48 hours earlier. Messages placed in the Trashcan within the last 24 hours are deleted at midnight the next day. The Trashcan is the first container the system empties when memory space is required (deleting as many messages as necessary to make room for incoming messages).

Outbox — Deletes all sent/unsaved messages from the transmission area of the Outbox starting with the oldest message first. The transmission status is retained but the text of each message is deleted.

Main Inbox —Deletes all read messages from the Main Inbox starting with the oldest message first.

Personal Inboxes — Deletes all read messages from personal inboxes starting with the oldest message first.

Information Services Inboxes — Deletes all read messages from each information service inbox starting with the oldest message first.

Reminders and Alarmed Messages — Deletes any alarmed inbox message or Reminder where the alarm has already gone off; messages are deleted in the following order:

1. Main inbox
2. Personal inboxes
3. Information Services inboxes
4. Reminders

- ↳ Alarmed messages that are set for periodic alarm (e.g. the alarm goes off every week) will not be deleted.

Unread Messages — If memory space is **still** needed, deletes unread messages from the inboxes in the order described above.

↳ Messages in Address Book entries and locked messages are not subject to automatic deletion.

When a warning message is displayed, the PageWriter 2000X Two-Way Wireless Communications Center enables you to access the View Memory Usage screen. Once you have determined the area where cleanup may be most effective, you can select:

Cleanup All — Deletes all sent and read messages in all inboxes and outboxes.

Cleanup Inboxes — Deletes all read messages in each inbox and does not affect the trashcan or the outbox.

Proper Care and Cleaning

The PageWriter 2000X Two-Way Wireless Communications Center is durable, reliable, and can provide many years of dependable service, but it is a precision electronic product. Water and moisture, excessive heat, and extreme shock may damage the pager. Do not expose your PageWriter 2000X Two-Way Wireless Communications Center to these conditions.

Use a soft, damp cloth to clean smudges and grime from your PageWriter 2000X Two-Way Wireless Communications Center.

Do not immerse in water. Do not use alcohol or other cleaning solutions.

To protect the operating system, applications, and data on your PageWriter 2000X Two-Way Wireless Communications Center, ensure that the PC from which you download files is protected by up-to-date virus protection software. Remember to archive your data, as needed.

General Safety Instructions

Follow these guidelines to ensure the safe use of your PageWriter 2000X Two-Way Wireless Communications Center and accessories.

Pager Transmitter Safety

The FAA has regulations concerning the use of electronic devices aboard aircraft. When boarding an aircraft, set the radio transmitter mode to Off on your PageWriter 2000X Two-Way Wireless Communications Center to avoid potential interference with aircraft radio communication or navigation equipment.

In hospital or blasting zones, set the radio transmitter mode to Receive Only. This prevents potential transmission interference with sensitive medical equipment or explosives devices.

Battery Safety

- Do not dispose of the rechargeable NiMH battery in fire. Batteries can explode when exposed to fire.
- To prevent injury or burns, do not allow metal objects to contact or short circuit the battery terminals.
- Recharge the Motorola 3.6 V NiMH battery (0186386G01) only with the recommended Motorola battery charger (0186388G02). Charging this battery by any other method or with a product not approved by Motorola may cause damage to the battery.
- Do not charge batteries other than Motorola's 3.6 V NiMH battery (0186386G01) in the Motorola battery charger (0186388G02). Charging other batteries can cause those batteries to burst or explode, resulting in personal injury or property damage.

Battery Charger Safety

- Do not expose the charger to rain or snow.
- Use of an attachment not recommended or sold by Motorola may result in a risk of fire, electric shock, or injury to persons.
- Make sure the cord is located where it will not be stepped on, tripped over, pinched, or subjected to damage or stress.
- If you need to use an extension cord, make sure:
 - the pins on the plug of the extension cord are the same number, size, and shape as those on the plug of the charger;
 - the extension cord is properly wired and in good electrical condition; and
 - the cord size is 18AWG for lengths up to 100 feet and

16AWG for lengths up to 150 feet.

- Do not operate the charger with a damaged cord, transformer block, or prongs; replace them immediately.
- Do not operate the charger if it has been damaged in any way; take it to a qualified service technician.
- Do not disassemble the charger; if service or repair is required, call Motorola at 1-800-548-9954. Incorrect reassembly can result in a risk of electrical shock or fire.
- Maximum ambient temperature around the power supply must not exceed 40±C (104±F).
- Keep battery contacts clean. Do not allow dirt or sticky substances to accumulate on the contacts. If you need to clean the contacts, unplug the charger to reduce the risk of electrical shock. Use a slightly dampened cloth to clean the contacts. Let the contacts dry before plugging the charger into an AC outlet. **Do not immerse in water.**

Agency Approvals

The PageWriter 2000X Two-Way Wireless Communications Center has been approved for use by the Federal Communications Commissions (FCC) and Underwriters' Laboratories, Inc. (UL). The charger/docking station has been FCC approved and the transformer has been UL approved.

Patent Information

This product is manufactured under one or more Motorola U.S. Patents. A partial listing of these patents is provided inside the battery compartment. Other patents covering this product are pending.

PageWriter 2000X Pager Specifications

Physical Dimensions

Size	3.75 x 2.85 x 1.2 in 95 x 72 x 29 mm
Weight (w/battery)	6.7 oz 190 g
Volume	9.3 in ³ 153 cc

Graphics Display

1/8 VGA	16 lines x 30 characters 240 x 160 pixels 4-level gray scale EL backlighting
Message Area	9 lines x 27 characters

Power

Main Battery Pack	3.6 V NiMH
Charge Time	1 hr
Backup Cell	rechargeable
Battery Life	>7 days
Clock Retention Time w/main battery removed	15 min
Max. Sound Pressure Level (at 12 inches)	72 dB

Memory

Total Memory	4.5 MB 4 MB Flash 3 MB (FLEX OS) 1 MB (Applications and Data) 512 KB RAM
--------------	--

Environment

Operating Temperature	32±to 122±F 0±to +50±C
Storage Temperature	14±to 149±F -10±to +65±C
Electrostatic Discharge (no permanent damage)	15kV

Commonly Asked Questions

Your PageWriter 2000X Two-Way Wireless Communications Center is a dynamic messaging device. It monitors and processes your communications even when you are busy with other things. The following questions reflect situations that may occur and are organized into four categories:

- PageWriter 2000X Pager
- Messaging
- Battery and Charger
- FLEX PC Partner

PageWriter 2000X Pager

Why won't my pager power up?

Your PageWriter 2000X Two-Way Wireless Communications Center might not be accessing the power it requires.

- Make sure you have a battery in the battery compartment. If not, insert a fresh battery.
- Make sure the battery is inserted properly. Check that the + marking on the battery is positioned on the two-contact side of the battery compartment. Press the battery into the compartment to ensure the battery is seated properly. For more information, see "To replace the battery:" on page 17.
- Recharge the battery or insert a fresh battery.
- If the front LED lights when you replace the battery and the screen is still blank, your screen's contrast may be too light. Adjust the contrast. See "My screen is too dark (or too light). How do I change it?"

My screen is too dark (or too light). How do I change it?

You can quickly change the contrast by pressing **ALT**, then holding down **↑** until reaching the desired contrast. Your PageWriter 2000X Two-Way Wireless Communications Center also has a built-in calibration guide to help you select the best contrast level. For more information, see Customizing the User Interface.

Periodically, the date and time are incorrect. What causes this?

The clock will maintain its accuracy for about an hour after the battery has been totally drained of power. To retain date and time accuracy, replace the battery, as needed. During extended periods of non-use (i.e., overnight), place your pager in the plugged-in

charger so the battery will be fully charged in the morning. While using your pager, an extra battery can be kept in the plugged-in charger until needed.

↳ The charger is intentionally designed so that you cannot place both the extra battery and the pager in the charger at the same time.

My pager is acting funny. What's wrong?

The amount of random access memory (RAM) available on your pager constrains the number of processes that can run at any given time. Symptoms of Low RAM status include:

- menu wheel won't spin
- time and date disappear from the screen
- all inbox message counts display zero
- Customize list box is empty
- text box is empty when attempting to forward a message
- nightly cleanup failed to run

These symptoms allow the pager to conserve RAM use. Reset your pager to correct the Low RAM status (turn your pager off, then back on again). To avoid a Low RAM status, turn off your pager at night when it is not being used.

↳ An Out-of-RAM status will cause the pager to reset itself.

Deleting my old messages did not help the Low Memory status. What should I do?

Messages that are deleted from inboxes are held in the Trashcan until the Trashcan is emptied. A cleanup schedule is assigned to empty the Trashcan. When you delete messages from inboxes to alleviate overuse of memory, you are only shifting memory use from one file storage area to another. After deleting messages, you must empty the Trashcan to free the memory for use (see "To empty the Trashcan:" on page 46).

Messaging

Why don't I receive messages?

Situations that will prevent you from receiving messages include:

- Your pager's radio mode may be set to Off. From the Home screen, the status line will display "Storing Messages". Reset your transmission mode to Send/Receive or Receive Only. For information on resetting your transmission mode, see "To set the transmission mode:" on page 23.
- Your pager might be out of range of the nearest transmitter. Check the icon in the lower right corner of the Home screen. If you are out of range, your messages will be transmitted when

you are back within transmission range.

Why does the Home screen status line read “Basic Service” when the radio mode is set to Send/Receive?

If you have just inserted a new battery or just disconnected the pager from your PC, it can take a few minutes before you have “Full Service” access. Your pager reregisters with the service provider after any suspension in service. Also, if you are on the perimeter of the transmission range, you might only have message reception capabilities.

Why does the Home screen status line read “Storing Messages”?

When your pager loses access to your service provider’s paging network, your messages are stored by the paging network until your pager is ready to receive the messages. Reasons why your pager might be unable to receive messages include:

- You have manually turned off transmission to your pager. This occurs by setting the transmission mode to Off (see “To set the transmission mode:” on page 23), or by turning off the pager (see “To turn off your pager:” on page 19).
- The pager may be in Low Memory status. To prevent lost incoming messages, transmission is turned off. Delete old messages from inboxes, then empty the Trashcan to increase the available memory. For more information, see “Deleting Messages” on page 39, “To empty the Trashcan:” on page 46, and “Memory Management System” on page 74).
- The battery might be too low to support two-way transmission. Replace or recharge the battery.

Why don’t I get alerted for incoming messages?

Your pager alerts might be set to silent. Alerts can be silenced in two ways:

- From the menu wheel, check to see if the pager is set to Silent mode. If so, change the mode to Loud, Soft, or Vibrate. For more information, see “To select an alert mode:” on page 26.
- Check the alert setting for each of your inboxes. If they are set to silent, reset the alerts. For more information, see “To select an alert type:” on page 26.

↳ If you are actively using the pager’s keyboard when receiving a message, your keystrokes can cancel a message’s alert before you hear or feel the alert.

Why do I keep getting reminder alerts?

Reminder alerts notify you of unread messages waiting in your inbox. Check each of your inboxes (Main, Information Service, Personal) for unread messages. Read the messages or disable the unread message alert. For more information, see “To enable/disable the unread message alert:” on page 48.

Why does my pager keep alerting me to the same message?

Your PageWriter 2000X Two-Way Wireless Communications Center sometimes receives garbled messages from the paging service provider. If you have read a garbled message and checked the *Alert for improved msg?* box, your pager will update the message when a less garbled version is received from the paging service provider. Your pager then alerts you to the change. If the updated version also contains garbled text, your pager will accept additional updates and notify you of each change.

If you have chosen not to be alerted, but have not deleted the message, your pager will update the message without notifying you.

If you have deleted a garbled message, you will not receive a new message alert for any improved message transmissions.

Why are my incoming messages placed in the wrong inbox?

Two situations can cause a message to be placed in the wrong inbox:

- The text string you identified as your filter when setting up the routing rules for your inbox might be too common. Any message containing the text string you indicated will be directed to the inbox using that filter. Detailed message filters will help limit misrouted messages.
- If more than one inbox is assigned the same filter (text string), the incoming message is sent to the first inbox that contains the matching text string. Check the filters for each inbox. See “To assign routing rules:” on page 41.

Why does the sending of my messages fail?

Ensure that you have Full Service transmission. Reset the transmission mode or, if you are out of transmission range, wait until you are back in transmission range. Select Resend from the Outbox to send your message.

↳ Some service providers limit the size of a message and if the message is too big, it will fail to be sent.

Why are messages disappearing from my inboxes?

Messages are removed from inboxes under two conditions:

- If you do not set a cleanup schedule for your inboxes, the auto-cleanup feature uses a default time frame of 5 days. Cleanup rules can be set for inboxes through the Read application. For more information, see “To assign a cleanup schedule to an inbox:” on page 42.
- When your pager has reached Low Memory status, the oldest read messages are deleted to free available memory for incoming messages. The order in which messages are deleted is discussed in “Memory Management System” on page 74.

Battery and Charger

The charger’s LED doesn’t light. What should I do?

Use the following procedure to find the cause:

1. Check that your pager, or the battery alone, is inserted into the charger correctly. See “The Battery and Charger” on page 12 for instructions.
2. Unplug the transformer from the AC power supply.
3. Remove the pager (or battery) from the charger, then use an ordinary pencil eraser to clean the six metal contacts on the charger and the pager (or battery).
4. Plug the transformer back into the AC power supply to restore the power.
5. Re-insert the pager or battery into the charger. If the charger’s LED still does not light, have the charger checked by an authorized service technician.

What does a flashing red indicator light on the charger mean?

The red flashing indicator light can mean one of four situations:

- The battery or pager may be seated improperly in the charger. Ensure the battery or pager is properly inserted.
- The battery voltage has remained low for too long a period of time and the battery cannot be recharged. Dispose of the battery properly and purchase a new battery.
- The battery temperature is outside the normal charging range. Remove the battery and re-insert. If flashing continues, remove the battery, wait one hour, and re-insert. If flashing continues replace battery or have the charger checked by an authorized service technician.
- Insufficient power is being delivered by the transformer. Plug the transformer into another power source.

- ↪ If the insufficient power is not corrected by changing the power source, the charger might be malfunctioning. Have the charger checked by an authorized service technician.

I just inserted a fresh battery, but it only lasted 2 days. Why?

When your PageWriter 2000X Two-Way Wireless Communications Center is set to two-way transmission but is not receiving Full Service (i.e., you are out of range), the pager continues to attempt to reestablish communication with the network. This acts as a continuous drain on the battery. Whenever you leave a two-way coverage zone, set the radio mode to One-way or Off to preserve the battery.

I haven't used my pager in two months. When I place the unit in the charger, I get a flashing red light. Do I need a new battery?

Your battery is hyper-drained and it needs to be reconditioned.

1. Place the battery in the docking station. The light will blink **red**.
2. Let the battery sit overnight.
3. If the light is still flashing **red** in the morning, remove the battery and put it back into the charger.
4. Repeat procedure until the light goes **green**. If after three attempts the battery doesn't charge to **green**, the battery cannot be reconditioned and must be replaced.

FLEX PC Partner

Why can't I establish a connection between my pager and my PC via the infrared interface?

Check the following before re-attempting to establish a connection:

- Make sure you have opened the FLEX PC Partner application on your pager and selected to get the Connect Status screen.
- Make sure your pager is placed properly in the docking station and that the RS232 cable and transformer are properly connected. For more information see "To connect the docking station to your computer:" on page 18.
- Make sure the communications port on your PC is correctly set. For more information, see "To configure FLEX PC Partner:" on page 56.

What caused my application installation to fail?

The pager may be in a Low RAM status or you may be attempting to load an application that is close in size to the available RAM. Remove the pager from the charger. Reset the pager by turning it off then back on again. Run the installation program again.

Partner stopped working during a download and is unresponsive. What should I do?

The battery might be drained of power. Replace or recharge the battery, and restart the Partner download.

Index

A

- accessories 18
- activation 5
- adapter 56
- Address Book 27, 58
 - add a group 28, 65
 - add an individual 27, 64
 - create file on PC 61
 - delete entries 30, 65
 - delete files 63
 - edit an individual's address 29
 - edit group membership 30
 - edit group name 29
 - edit on PC 64
 - file management 61
 - forcing position in list to top or bottom 27, 66
 - import files 62
 - import files from other PC-based applications 62
 - merge files 62
 - open file on PC 62
 - print 67, 68
 - save file on PC 61
 - save file with new name 61
 - transfer data from pager to PC 59
 - transfer data from PC to pager 60
- Addresses
 - application overview 1
- ADR files 58
- airline travel 23
- Alarm Clock
 - application overview 2
- Alarm clock
 - setting
- alarm clock 53
- alarmed messages
 - memory management 74
- alarms
 - enable/disable 48
 - reminder message 37
 - See also* alerts
- alert modes 25
 - icon 7
 - overview 7
 - shut off alerts 7
- alert types 26, 42
- alerts 48

- See also* alarms
- unread message 48

- Alt functions 11
- Alt-mode functions 11
 - Alt key 10
- applications
 - delete 52
 - Home screen 6
 - install on pager 70
 - menu wheel 6

B

- Back to Previous Screen key 10
- back to previous screen key 10
- Backlight key 11
- Backspace key 10
- backup 71
- Backup Utility 72
- Basic Service coverage 23
 - icon 8
- battery 12
 - icon 7
 - insert into pager 17
 - recharge outside of pager 16
 - recharge while in pager 13
 - remove 15
 - safety instructions 76
- battery charger 76
 - See* charger
- battery gauge
 - overview 7
- book conventions 3

C

- cancel outgoing messages 44
- canned text
 - attach replies for addressee 33
 - See* Quick Text
- care and cleaning of pager 75
- charger 12
 - docking station 18
 - safety instructions 76
- Cleanup 52
- cleanup
 - inboxes 75
- Cleanup All
 - memory management 75
- Cleanup Inboxes 42
 - memory management 75
- configuration
 - FLEX PC Partner 56

- infrared port 56
 - pager 23
 - port settings, PC 56
- connect pager to PC 18, 55
- contrast
 - adjust 11, 49
 - calibration guide 49
 - icon 11
- control keys 9
- conventions 3
- copy
 - data from pager to PC 72
 - data from PC to pager 72
 - message text 70

- create
 - Address Book file 61
 - Quick Text 51
 - signature 50
- Customize 47
 - application overview 1

D

- date
 - format 25, 49
 - overview 7
 - set 24
- delayed send 34
- delete
 - Address Book entries 30, 65
 - Address Book files 63
 - applications 52
 - applications from pager 71
 - group's address 67
 - inboxes 43
- docking station 18
- draft messages 34

E

- edit
 - individual's address 64
 - Quick Text 51
- email
 - create addresses 27
 - individual 64
 - send messages to an email address 31
- empty the Trashcan 46
- Enter key 10

F

- failed message

- resend 45
- FAQs 79
- fax
 - create addresses 27, 64
 - send messages to a fax machine 31, 48
 - service 48
- features 1
- files
 - backup 71
- FLEX PC Partner
 - application overview 1
 - configure 56
 - installation 55
 - online help 55
 - open partlets 57
 - program description and instructions 54
- FLEX PC Partner Shell
 - open the shell 57
 - overview 57
 - partlets 57
 - right-click menu 57
- flip 6
- forward messages 38, 45
- Full Service coverage 23
 - icon 8

G

- Get From Pager 59
- group
 - add members 28, 66
 - create 28, 65
 - delete 67
 - delete members 67
 - members list 65
 - rename 29, 65

H

- hardware
 - requirements, PC 54
 - update configuration 56
- help
 - FAQs 79
 - Internet address 4
 - product support 4
 - technical support 4
- holster 18
- Home
 - phone number 64
- home

- Home key 10
- screen 6
- hospital environment 76

I

- icons
 - alert mode 7
 - battery gauge 7
 - new message waiting 8
 - one-way transmission 8
 - smart transmission 8
 - special status 8
 - transmitter off 8
- Import
 - add to message 32
- import
 - Address Book files 62
 - Address Book files from other PC-based applications 62
- inboxes 40
 - assign cleanup schedule 42
 - assign routing rules 41
 - clean up 42, 52
 - create 40
 - delete 43
 - memory management 74
 - rename 41
 - save a message 33, 39
 - set alert types 42
 - view messages 43
- Information Services inboxes
 - memory management 74
- infrared port
 - configure 56
 - connect pager to PC 55
 - connection 56
- insert battery 17
- installation
 - FLEX PC Partner 55
 - new applications on pager 70
- Internet address 4
- IR
 - See IR Port
- IR Port 17

K

- key click 24, 50
- keyboard 9
 - control keys 9
 - NavDisc 9
 - Select key 10

L

- LCD screen 6
- LED alarms 48

M

- Main Inbox
 - memory management 74
- maximum characters allowed 64
- memory
 - management 74
 - usage level 47, 73
- memory management
 - alarmed messages 74
 - Cleanup All 75
 - Cleanup Inboxes 75
 - Information Services inboxes 74
 - Main Inbox 74
 - Outbox 74
 - personal inboxes 74
 - reminders 74
 - Trashcan 74
 - unread messages 75
- menu wheel 6
- merge Address Book files 62
- Message Area 39
- messages
 - cancel 44
 - canned responses 33, 38
 - cleanup schedule 41
 - copy text 70
 - custom responses 37
 - delete 39
 - details 45
 - drafts 34
 - forward 38, 45
 - print 69
 - read on the pager 36
 - read on the PC 69
 - reply 37
 - resend 44
 - restore 46
 - save copy of sent message 33
 - save on the PC 70
 - schedule send 34
 - text size 49
 - transfer from pager to PC 69
 - write 31
- MPSHELL.EXE 57

N

- NavDisc 7, 9

- navigation
 - NavDisc 9
 - Select keys 10
 - Tab key 10
- notes 64

O

- one-time address 35
- one-way transmission
 - icon 8
- Outbox 44
 - cancel outgoing messages 44
 - forward messages 45
 - memory management 74
 - resend failed message 45
 - resend messages 44
 - view message information 45
- overview 1
 - FLEX PC Partner Shell 57
 - PageWriter 2000X 6
- owner information 47

P

- pager
 - care and cleaning 75
 - configure 23
 - features overview 6
 - PIN 64
 - reset 19
 - specifications 78
 - type 64
 - virus protection 75
- paging service, activate 5
- partlets 57
 - open 57
- PC Partner
 - program description and instructions 54
- personal inboxes
 - See inboxes
- PIN
 - from paging service 5
- port settings 56
- power
 - off 11, 19
 - on 19
 - See charger
- print preview 68
- printer setup 68
- printing
 - Address Book information 67, 68

- messages 69
 - preview 68
 - setting up printer 68
- product support 4

Q

- Quick Text
 - add to message 33
 - create 51
 - edit 51

R

- Radio Mode
 - application overview 2
- radio mode
 - set 23
- Read 36
 - application overview 1
- read messages
 - on the pager 36
- recharge battery 13, 16
- reminder message alarm 37
- reminders
 - memory management 74
- remove
 - applications from pager 71
 - group's address 67
 - individual's address 65
- remove battery 15
- replies, attaching 33
- reply to messages 37
- resend failed message 45
- resend messages 44
- reset pager 19, 80
- restoration 71
- restore messages 46
- Restore Utility 72
- right-click menu 58
- routing rules 40, 41
- rules, message routing 40

S

- safety instructions 76
- save
 - Address Book files 61
 - messages on the pager 39
 - messages on the PC 70
- Select key 10
- Send To Pager 60
- service activation 5
- Set Time

- application overview 1
- shell
 - See* FLEX PC Partner Shell
- Shift-mode functions 12
 - Shift key 11
- shortcuts 7
- shut off alerts, Silent mode 7
- signature
 - append to messages 50
 - create 50
- sleep mode 6
- smart transmission
 - icon 8
- software requirements, PC 54
- Space key 10
- specifications
 - PageWriter 2000X 78
- status line 8
- Storing Messages coverage 8, 23
- symbols 12
- system
 - information 47
 - setup 19
 - status 47

T

- Tab key 10
- technical support 4
- text
 - See* Import Message
- text size 24, 49
- time
 - format 25, 50
 - overview 7
 - set 24
- transfer
 - Address Book data from pager to PC 59
 - Address Book data from PC to pager 60
 - Address Book information 58
 - messages 69
- transmission
 - icons 8
 - set mode 23
 - status 8
 - status log 44
- transmitter
 - OFF icon 8
 - safety instructions 76
- Trashcan 39, 46
 - empty 46

- memory management 74
- restore messages 46
- troubleshooting 79
 - battery and charger 83
 - FLEX PC Partner 84
 - messaging 80
 - PageWriter 2000X pager 79

U

- uninstall
 - FLEX PC Partner 73
 - See also* applications, delete
- unread messages
 - alert 48
 - memory management 75
- update
 - hardware 56

V

- version number
 - FLEX Operating System 47
 - FLEX PC Partner partlets 58
 - PageWriter 2000X applications 47
- view message information 45
- virus protection 75

W

- web address 4
- work phone 64
- Write 31
 - application overview 1
 - email 31
 - fax 31
 - Import Message 32
 - message 31
 - Quick Text 33

Notes
